

2016-04

Modelling the dynamics of rabies transmission among dogs and to human and livestock in communities within and around Addis Ababa, Ethiopia

Ega, Tesfaye

NM-AIST

<https://doi.org/10.58694/20.500.12479/52>

Provided with love from The Nelson Mandela African Institution of Science and Technology

**MODELLING THE DYNAMICS OF RABIES TRANSMISSION AMONG
DOGS AND TO HUMAN AND LIVESTOCK IN COMMUNITIES
WITHIN AND AROUND ADDIS ABABA, ETHIOPIA**

Tesfaye Tadesse Ega

**A Dissertation Submitted in Partial Fulfilment of the Requirements for the Degree of
Master's in Mathematical and Computer Sciences and Engineering of the Nelson
Mandela African Institution of Science and Technology**

Arusha, Tanzania

April, 2016

ABSTRACT

Rabies is one of the neglected tropical diseases that has persisted for centuries in Ethiopia, and it is endemic within and around Addis Ababa. In this dissertation, we propose a deterministic mathematical model with vaccination to study the dynamics of rabies transmission within and around Addis Ababa. The model comprises human, dog and livestock populations and formulated as a system of ordinary differential equations.

Basic reproduction number R_0 and effective reproduction number R_e are computed using next generation operator. For specified values of parameters R_0 and R_e work out to be 2 and 1.6 respectively, which indicate the disease will be endemic. When $R_e < 1$ the disease-free equilibrium ε_0 is globally asymptotically stable in a feasible region Φ . When $R_e > 1$ there exists one endemic equilibrium point which is locally asymptotically stable.

According to sensitivity analysis, the natural death rate of dogs μ_d , the annual birth rate of dogs ϑ_d , dog-to-dog transmission rate β_d , and disease induced death rate of dogs σ_d are found to be the most sensitive parameters of R_e . Numerical simulations of our system show that rabies transmission will increase within and around Addis Ababa, and will peak in 2026 and 2033 in human and livestock populations respectively. Applying 25% vaccination coverage for livestock population will reduce the future infection by half. This study suggests that a combination of interventions consisting of 60% of vaccination coverage in dog population, 15% culling of stray dogs, and reducing the annual crop of newborn puppies by 25% will reduce the number of human and livestock infections by 70%, and the disease will be eradicated from the community.

DECLARATION

I, Tesfaye Tadesse Ega, do hereby declare to the Senate of Nelson Mandela African Institute of Science and Technology that this dissertation titled “*Modelling the Dynamics of Rabies Transmission Among Dogs, and to Human and Livestock in Communities Within and Around Addis Ababa Ethiopia*” is my own original work and that it has neither been submitted nor being concurrently submitted for a similar degree award in any other university.

Tesfaye Tadesse Ega



Name and signature of candidate

18/04/2016

Date

The above declaration is confirmed

Prof. Livingstone S. Luboobi

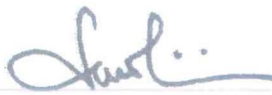

Name and signature of supervisor 1

7 April 2016

Date

Prof. Dmitry Kuznetsov



Name and signature of supervisor 2

20/04/2016

Date

COPYRIGHT

This dissertation is copyright material protected under the Berne Convention, the Copyright Act of 1999 and other international and national enactments, in that behalf, on intellectual property. It must not be reproduced by any means, in full or in part, except for short extracts in fair dealing; for researcher private study, critical scholarly review or discourse with an acknowledgement, without the written permission of the office of Deputy Vice Chancellor for Academics, Research and Innovations, on behalf of both the author and the Nelson Mandela African Institution of Science and Technology.

© Tesfaye Tadesse Ega

CERTIFICATION

The undersigned certify that they have read and found the dissertation acceptable by the Nelson Mandela African Institution of Science and Technology.

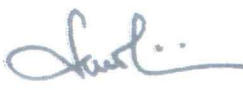
Prof. Livingstone S. Luboobi 
Name and signature of Supervisor 1

7 April 2016

Date

Prof. Dmitry Kuznetsov 
Name and signature of Supervisor 2

20/04/2016

Date

“It always seems impossible until it’s done.”

Nelson Mandela

ACKNOWLEDGEMENTS

First and most importantly, I would like to thank the Almighty GOD for his sufficient grace and mercy, who enabled me to finish my studies.

I would like to express my deepest gratitude to my supervisors Prof. Livingstone S. Luboobi (Makerere University, Uganda) and Prof. Dmitry Kuznetsov (NM-AIST, Tanzania) for their guidance and encouragement throughout my effort towards the end. You became like fathers to me, not only supervisors- May God bless you

Special thanks goes to Mr. Jemma David Ndibwile for his willingness and assistance throughout my entire study period, Dr. Netsanet Abebe for her professional advice on the nature of rabies and its transmission. Dr. Abraham Haile Kidane for his kindness and assistance in the process of data collection at the Ethiopian Public Health Institute.

I am very grateful to the African Capacity Building of NM-AIST for granting me a full scholarship. Many thanks to my friends Zoë Campbell, Goodluck Mlay, Leopard Mpande, Justin Kisakali and the NM-AIST community as a whole, you were all behind my success. Thank you so much.

DEDICATION

I dedicate this work to my wife, Betelhem Gedlu Hailemeskel for her unconditional love and encouragement. She is faithful to me under any circumstances. May God bless you abundantly and help you to prosper in all your dimensions. Your prayer always keeps me strong during challenges. To my beloved family as well.

TABLE OF CONTENTS

ABSTRACT	i
DECLARATION	ii
COPYRIGHT	iii
CERTIFICATION	iv
ACKNOWLEDGEMENTS	vi
DEDICATION	vii
LIST OF TABLES	x
LIST OF FIGURES	xi
LIST OF APPENDICES	xii
LIST OF ABBREVIATIONS AND SYMBOLS	xiii
CHAPTER ONE	1
Introduction	1
1.1 Background Information.....	1
1.2 Problem Statement	2
1.3 Justification.....	2
1.4 Objectives	3
1.4.1 General Objective	3
1.4.2 Specific Objectives	3
1.4.3 Research Questions.....	3
1.4.4 Dissertation Outline	3
CHAPTER TWO	5
Modelling the Dynamics of Rabies Transmission with Vaccination and Stability Analysis	5
2.1 Introduction.....	5
2.2 Materials and Methods.....	8
2.2.1 Model Formulation	8
2.2.2 Model Compartment	10
2.2.3 Model Equations	11
2.3 Model Analysis	16
2.3.1 Disease Free Equilibrium Points (DFE).....	16
2.3.2 The Basic Reproduction Number, R_0	16

2.3.3	The Effective Reproduction Number, R_e	19
2.4	Stability Analysis	20
2.4.1	Local Stability of the Disease Free Equilibrium Points	20
2.4.2	Global Stability of Disease Free Equilibrium Points	22
2.5	Endemic Equilibrium Points	25
2.5.1	Existence of Endemic Equilibrium Points	25
2.5.2	Local Stability of the Endemic Equilibrium Points	26
2.6	Conclusion	29
CHAPTER THREE		30
Sensitivity Analysis and Numerical Simulations for the Mathematical Model of Rabies in Human and Animal Within and Around Addis Ababa		30
3.1.	Introduction.....	30
3.2.	Sensitivity Analysis of R_e with Respect to the Model Parameters.....	33
3.3.	Numerical Results and Discussion.....	36
3.4.	Discussion and Conclusion	41
CHAPTER FOUR		44
General Discussion, Conclusion and Recommendations		44
4.1	General Discussion	44
4.2	Conclusion	45
4.3	Recommendations.....	47
REFERENCES		48
APPENDICES		50

LIST OF TABLES

Table 2.1: Description of parameters.....	9
Table 3.1: The parameter values of the model.....	34
Table 3.2: Sensitivity indices of R_e	35

LIST OF FIGURES

Figure 2.1: Flow diagram for rabies transmission among dogs and to human and livestock in which the parameters are as defined in Table 2.1.	10
Figure 3.1: Reproduction number for different vaccination coverages and combination of vaccination, culling and controlling newborn puppies.	33
Figure 3.2: Comparison between reported data and simulation of system (2.1) for rabies infected humans in and around Addis Ababa from 2008 to 2014.	37
Figure 3.3: The dynamics of rabies in infected humans for the next 34 years in and around Addis Ababa.....	38
Figure 3.4: The effect of annual birth of dogs ρ_d for human rabies infection.	38
Figure 3.5: Transmission of rabies in dog population in 40 years' time.	39
Figure 3.6: Comparison between the reported data and the model simulation of infected livestock population from 2008 to 2014.	40
Figure 3.7: The trend of livestock populations with different vaccination coverage in 40 years time.....	40
Figure 3.8 Effects of combining interventions in dog populations (CIDP) on human and livestock rabies infection.	42
Figure 3.9 Comparison between no vaccination and 25% vaccination for rabies infected livestock.	42

LIST OF APPENDICES

Appendix 1: MATLAB Codes for Fig. 3.1.....	50
Appendix 2: MATLAB Codes for Fig. 3.2.....	51
Appendix 3: MATLAB Codes for Fig. 3.3.....	52
Appendix 4: MATLAB codes for Fig. 3.4.....	53
Appendix 5: MATLAB codes for Fig. 3.5.....	54
Appendix 6: MATLAB codes for Fig. 3.6.....	55
Appendix 7: MATLAB codes for Fig. 3.7.....	56
Appendix 8: MATLAB codes for Fig. 3.8.....	57
Appendix 9: MATLAB codes for Fig. 3.9.....	59

LIST OF ABBREVIATIONS AND SYMBOLS

CIDP	Combined Interventions in Dog Populations
DFEP	Disease Free Equilibrium Point
EEP	Endemic Equilibrium Point
EPHI	Ethiopian Public Health Institute
NM-AIST	Nelson Mandela African Institution of Science and Technology
PEP	Post Exposure Prophylaxis
R_0	Basic Reproduction Number
R_e	Effective Reproduction Number
WHO	World Health Organization
DVC-AIR	Deputy Vice Chancellor-Academic, Innovation and Research

CHAPTER ONE

Introduction

This chapter describes the general introduction of the study. It mainly focuses on the background information about rabies virus and its burden in developing nations, the problem statement and justification, objectives, research questions and structure of the dissertation.

1.1 Background Information

Rabies is a zoonotic viral disease that causes an acute inflammation of brain in human and other warm blooded animals. It is transmitted by saliva of infected animal via bites or scratch. Once the virus enters the body through a skin opening, it travels via nerve tissues to the brain where the virus duplicates itself. During this time the host experiences a range of symptoms from fever to hallucinations, paralysis, and eventually death (Addo, 2012; Khan, 2012). Salivary glands are attacked after the virus duplicate in the brain, then the saliva becomes the main instrument for infecting other animals.

Rabies occurs in more than 150 countries and territories around the world, and it is very high in developing continents like Africa and Asia. Poor rural communities are highly vulnerable to rabies due to interaction with domestic animals like dogs. Globally 55 000 people die due to rabies per annum. The figure is estimated to be more due to lack of enough surveillance and under reporting in developing countries (Knobel *et al.*, 2005). More than 40% of the people who are bitten by infected (rabid) animals are children, which is explained by the higher tendency of children to play with animals. More than 15 million people receive post exposure vaccination worldwide (WHO, 2013).

Besides its effect on humans, rabies also puts significant burden on the livestock populations in Africa and Asia. This can be directly reflected by its economic effect in rabies endemic areas. Africa and Asia lose US\$12.3 million annually because of death of livestock due to rabies (Jemberu *et al.*, 2010).

Domestic dogs are highly affected by rabies and they are the source for almost all types of human and livestock infection (Deressa *et al.*, 2010). The main terrestrial reservoirs of rabies are domestic dog populations of the developing world (Nel, 2013). Classical rabies virus is mainly found in dogs worldwide and more than 3 billion people in developing countries are exposed to dog rabies. In India for example about 15 million people are bitten by dogs annually (Khan, 2012).

Rabies cases are reported from all regions of Ethiopia, and it has persisted for centuries (Reta *et al.*, 2014). Addis Ababa and its surroundings are the endemic parts of the country (Ali *et al.*, 2010). More than 2000 people were bitten by dog annually in and around Addis Ababa. A retrospective record review from 2001 to 2009 shows that 386 deaths in humans were reported with an annual range of 35 to 58. From this 42.72% were children under the age of 14 (Deressa *et al.*, 2010). Livestock are also highly affected by rabies due to dog bites within and around Addis Ababa (Reta *et al.*, 2014).

1.2 Problem Statement

Few studies have been conducted on the transmission of rabies within and around Addis Ababa, but the disease has been prevalent in human and animal for a century. Addis Ababa and its surroundings are rabies endemic part of the country. Retrospective record review shows that rabies cases have been increasing in and around Addis Ababa. From the total human death due to rabies recorded for nine years, more than 42% of them were children. It is likely that some deaths are unreported. Livestock are also victims of rabies virus, but are not considered in many mathematical epidemiology studies. Therefore, there is a need for more studies to analyze the parameters which have been driving the transmission of the diseases.

1.3 Justification

Many societies especially poor rural communities have traditional beliefs towards rabies. For instance, in many areas inhalation is taken as a means of rabies transmission and traditional healers are believed to be the best solution for treatment. Awareness should be created about the transmission and control of rabies since misconception is very common in these areas. It is believed that this study will motivate governments and stakeholders to sensitize the societies in creating the right perception of the virus transmission and control. In addition to that, the result of this study will create awareness on how rabid domestic dogs affect poor rural community people and their livestock. It will also contribute to the national rabies surveillance system. Government, policy makers and all sectors involved in this campaign will benefit from a new approach to combating rabies transmission.

The few studies like Zhang *et al.*, (2011), Hou *et al.*, (2012) and Addo (2012) have formulated SEIR mathematical model to show the spread of rabies among dogs and from dogs to human, but none of them have tried to show how the disease is spreading in livestock population which are the livelihood of poor communities.

1.4 Objectives

The general and specific objectives of the study are as follows:

1.4.1 General Objective

The general objective of this study is to develop and analyze a mathematical model for the dynamics of rabies transmission among dogs and to human and livestock populations.

1.4.2 Specific Objectives

- i. To formulate a model for the interaction that enhances the transmission of rabies among dogs and to human and livestock.
- ii. To determine the disease free and endemic equilibrium points and their stability.
- iii. To determine the sensitivity of the dynamics of the diseases with respect to embedded parameters of the model, and to come up with numerical solutions of the model.

1.4.3 Research Questions

- i. What type of interactions between dogs, humans and livestock enhance the transmission of rabies?
- ii. What are the conditions for existence and stability of equilibrium points?
- iii. To which parameters is the dynamics of the disease more sensitive?

1.4.4 Dissertation Outline

This dissertation consists of four chapters.

Chapter 1: This chapter focuses on the general introduction of the problem and reviews literature related to the study.

Chapter 2: This chapter is based on the first paper titled *Modeling the Dynamics of Rabies Transmission with Vaccination and Stability Analysis*. Formulation of the mathematical model, derivation of the effective and the basic reproduction numbers by using next generation operator and conditions for stability of disease free and endemic equilibrium points of the model are presented.

Chapter 3: In this chapter we present the second paper, *Sensitivity Analysis and Numerical Simulations for the Mathematical Model of Rabies in Human and Animal Within and Around*

Addis Ababa. Sensitivity analysis of the effective reproduction number and numerical simulations of system 2.1 are presented.

Chapter 4: In chapter four general discussion, conclusion and recommendations are presented.

CHAPTER TWO

Modelling the Dynamics of Rabies Transmission with Vaccination and Stability Analysis¹

Abstract: We propose a deterministic mathematical model which comprises human, dog and livestock populations, and formulated as a system of ordinary differential equations. The basic reproduction number R_0 and effective reproduction number R_e are computed using the next generation operator. The results are entirely dependent on the parameters of dog populations, which shows that dog populations are the source of rabies infection for both human and livestock populations. The disease-free equilibrium \mathcal{E}_0 is computed, when $R_e < 1$ it is proven to be globally asymptotically stable in the feasible region Φ . When $R_e > 1$ there exist one endemic equilibrium point which is locally asymptotically stable. For a specified set of values of parameters R_0 and R_e are 2 and 1.6 respectively, which indicates that the disease is endemic within and around Addis Ababa.

Key Words: Rabies, Addis Ababa, Endemic, Reproduction number, Equilibrium points

2.1 Introduction

Rabies is a zoonotic viral disease that causes an acute inflammation of brain in human and other warm blooded animals. It is transmitted by saliva of an infected animal via bites or scratches. Once the virus enters the body through a skin opening, it travels via nerve tissues to the brain where the virus duplicates itself. During this time the host experiences a range of symptoms from fever to hallucinations, paralysis, and eventually death (Addo, 2012; Khan, 2012). Salivary glands are attacked after the virus duplicates in the brain, then the saliva becomes the main instrument for infecting other animals.

Rabies occurs in more than 150 countries and territories around the world, and it is very high in developing continents like Africa and Asia. Poor rural communities are highly vulnerable to rabies due to interaction with domestic animals like dogs. Globally 55 000 people die due to

¹ This chapter is based on published research paper:

Tesfaye Tadesse Ega, Livingstone S. Luboobi, Dmitry Kuznetsov. 'Modeling the Dynamics of Rabies Transmission with Vaccination and Stability Analysis', Applied and Computational Mathematics, Vol. 4, No. 6, 2015, pp. 409-419. doi: 10.11648/j.acm.20150406.13

rabies per annum. The figure is estimated to be more due to lack of enough surveillance and under reporting in developing countries (Knobel *et al.*, 2005). More than 40% of the people who are bitten by infected (rabid) animals are children, which are explained by the higher tendency of children to play with animals. More than 15 million people receive post exposure vaccination worldwide (WHO, 2013).

Besides its effects on humans, rabies also puts a significant burden on the livestock population in Africa and Asia. This can be directly reflected by its economic effect on rabies endemic areas. Africa and Asia lose US\$12.3 million annually because of deaths of livestock due to rabies (Jemberu *et al.*, 2014).

Domestic dogs are highly affected by rabies and they are the source for almost all types of human and livestock infection (Deressa *et al.*, 2010). The main terrestrial reservoirs of rabies are domestic dog populations of the developing world (Nel, 2013). Classical rabies virus is mainly found in dogs worldwide and more than 3 billion people in developing countries are exposed to dog rabies. In India for example about 15 million people are bitten by dogs annually (Khan, 2012).

Rabies cases are reported from all regions of Ethiopia, and it has persisted for centuries (Reta *et al.*, 2014). Addis Ababa and its surroundings are the endemic parts of the country (Ali *et al.*, 2010). More than 2000 people are bitten by dog annually within and around Addis Ababa. A retrospective record review from 2001 to 2009 shows that 386 deaths in humans due to rabies were reported with an annual range of 35 to 58. From this 42.72% were children under the age of 14 (Deressa *et al.*, 2010). Livestock are also highly affected by rabies due to dog bites within and around Addis Ababa (Reta *et al.*, 2014).

Mathematics has played an important role in understanding and controlling the spread of infectious diseases, and it is a powerful tool for analyzing and predicting the dynamics of phenomena. It also helps medical professionals to organize their thinking (Hethcote, 2000; Lloyd & Valeika, 2007).

In all few studies like Zhang *et al.*, (2011), Hou *et al.*, (2012) and Addo (2012) they formulated SEIR mathematical model to analyze the dynamics of rabies transmission among dogs and from dogs to human, but none of them incorporate livestock populations which are the livelihood of poor communities. In addition to that there is no strong mathematical model

which analyses and predicts the dynamics of rabies transmission within and around Addis Ababa.

An SEIR (Susceptible-Exposed-Infected-Removed) standard model was developed by Addo (2012) to determine and predict the spread of rabies among dogs in Bongo District Ghana. Both SEIR model with vaccination and SEIR model without vaccination were formulated with ordinary differential equations. The reproductive ratio without vaccination was determined to be greater than one which showed the virus would be endemic, and less than one with vaccination, which showed that the disease dies out. The study also applied sensitivity analysis to the model by using different numbers of infectious dogs and vaccinated dogs. The study determined the reproductive number, R_0 of rabies transmission decrease as vaccination is introduced into the model. In addition, the model showed that rabies transmission can be decreased by the strategy of keeping dogs confined within their household.

The other deterministic SEIR model was developed by Zhang *et al.*, (2011) to analyze the control and transmission of rabies among dogs and from dogs to human in China. Both dogs and human were included and classified into susceptible, exposed, infectious, and recovered classes. They first simulated human rabies from 1996 to 2010 using the data reported by Chinese Ministry of Health, and the numerical simulation they got significantly supported the data. They also estimated the basic reproductive rate $R_0 \approx 2$ for rabies transmission in China. Sensitivity analysis of R_0 was performed in terms of the model parameters and compared the effects of culling and immunizing of dogs. Their results showed that reducing dog birth rates and increasing dog immunization coverage rates are the most effective methods in controlling human rabies infection in China. They recommend that culling of dogs can be replaced by immunization of dogs. The reason is that in the process of culling of dogs, human community can be disturbed. Additionally culling can cause increased movement of infected dogs to less infected areas. Their model predicted that rabies transmission in China will decrease for the coming 7 to 8 years and it will peak again in 2030.

SEIV (Susceptible-Exposed-Infectious-Vaccinated) model was formulated by Hou *et al.*, (2012) for the transmission of rabies among dogs, and from dogs to human in the context of Guangdong province of China. In their model domestic and stray dogs were taken as different groups, and the model was governed by twelve differential equations. In this study, sensitivity analysis of the reproduction rate was determined in terms of various parameters. The

reproduction rate was $R_0 \approx 1.65$ which is less compared to the result of Zhang *et al.*, (2011) which was $R_0 \approx 2$. According to their results the recruitment rate of domestic dogs, the number of stray dogs and the valid time of immunity play a very important role for the transmission of rabies.

In this study we propose a mathematical model for the transmission dynamics of rabies from dogs to both human and livestock in the context of Addis Ababa and its surrounding areas. The model is based on SEIR type and domestic dogs infect both human and livestock populations. We have used the improved model of Zhang *et al.*, (2011) to incorporate livestock populations. Though livestock populations are highly affected by rabies virus, they have not been considered in the above studies.

2.2 Materials and Methods

2.2.1 Model Formulation

In this chapter we formulate SEIR (Susceptible-Exposed-Infected-Recovered) model of rabies for human, dog and livestock populations. We categorize the human, dog and livestock populations into susceptible, exposed, infected and recovered groups. Susceptible groups have no disease, but they are likely to be infected in case of contact with rabid dogs. Exposed individuals are those who contracted the virus via bites or scratches, but still they have not shown symptoms. Infected individuals are those who develop clinical symptoms and they are unlikely to recover due to the nature of rabies. The recovered classes are those who recovered through vaccination before they reach infectious stage, whereas the rest get infected and die eventually.

The human population is grouped into susceptible, S_h , exposed, E_h , infectious, I_h , and recovered, R_h . Individuals are recruited to susceptible class by birth at a rate of ϑ_h . A susceptible man bitten by a rabid dog becomes exposed. If post-exposure treatment is not given the person become infectious and dies since there is no recovery at infectious stage.

The dog population is divided in to susceptible, S_d , exposed, E_d , infectious, I_d and recovered, R_d . Individuals are recruited into susceptible class by birth at a rate ϑ_d . For susceptible dogs vaccination is applied at a rate of φ_d . This is because it is the dog population which infects both human and livestock populations. An exposed dog automatically moves to

the infectious class since the community cannot observe which dog is infected as many dogs are very mobile around the city.

It is assumed that all parameters of the model are positive and they are described in Table 2.1

Table 2. 1: Description of parameters.

Parameter	Description
$\mathcal{G}_h, \mathcal{G}_d, \mathcal{G}_l$	The annual birth rate of human, dog and livestock populations respectively per annum
$\sigma_h, \sigma_d, \sigma_l$	Death rate due to rabies for human, dog and livestock populations respectively
$\omega_h, \omega_d, \omega_l$	The loss rate of vaccination immunity for human, dog and livestock populations respectively
μ_h, μ_d, μ_l	Natural death rate of human, dog and livestock populations respectively
$\beta_h, \beta_d, \beta_l$	The rate at which infectious dogs infect susceptible human, dog and livestock populations respectively
ρ_h, ρ_d, ρ_l	The incubation period in human, dog and livestock populations respectively
$\varphi_h, \varphi_d, \varphi_l$	Vaccination rate of exposed human, dog and livestock populations respectively

Livestock populations are also divided into susceptible, S_l , exposed, E_l , infectious, I_l and recovered, R_l . Individuals are recruited to susceptible class by birth at a rate \mathcal{G}_l . Members of the susceptible class contract the disease from dog bites or scratches. Livestock which are bitten by a rabid dogs become exposed. If post exposure treatment is provided the individual moves to recovered class before reaching the infectious stage.

Our model is developed based on the following assumptions.

- i. Susceptible populations are recruited by birth at a rate of \mathcal{G} ;
- ii. Rabies transmission among humans, among livestock and between human and livestock was ignored due to rare cases;
- iii. An individual who is bitten or scratched by rabid dog becomes exposed;
- iv. Individuals in each group have equal natural death rate;

- v. Populations are homogeneous, that is each individual has equal probability of being bitten or scratched by a dog and thereby contracting the diseases;
- vi. Once an individual reaches to infectious stage there is no recovery and death is 100% certain.

2.2.2 Model Compartment

Using the above assumptions, definition of variables and parameters, the model flow diagram which depicts the dynamics of rabies transmission among dogs and from dogs to both human and livestock is shown in Fig. 2.1.

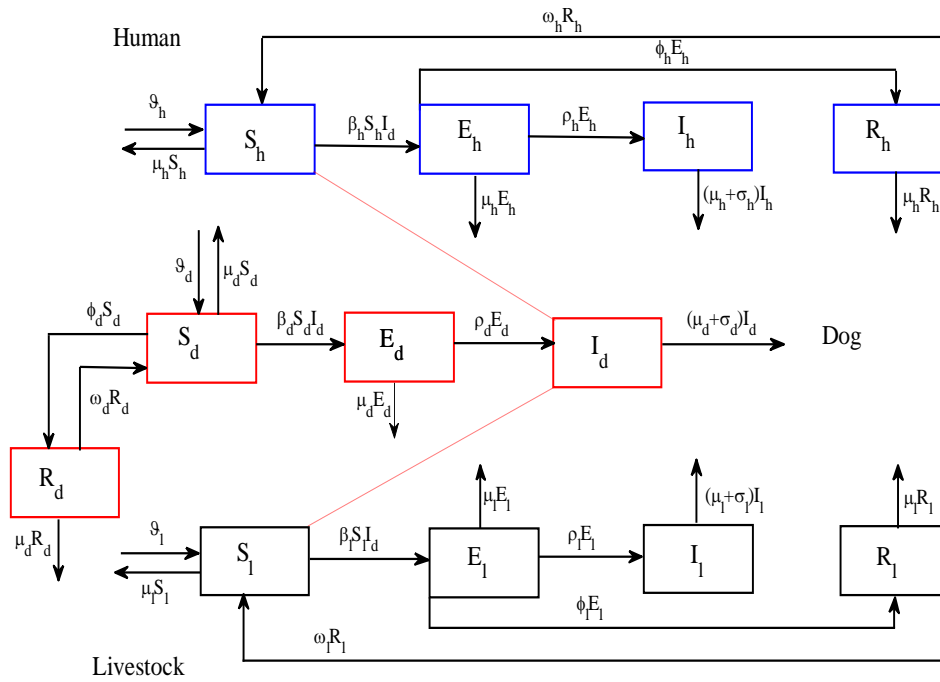

Figure 2.1: Flow diagram for rabies transmission among dogs and to human and livestock in which the parameters are as defined in Table 2.1.

The parameters of the model are positive. \mathcal{G}_i where $i = h, d, l$ represents the annual birth of dog, human and livestock populations respectively. Exposed population of human and livestock can recover through post exposure treatment. The parameters ρ_i where $i = h, d, l$ represent the latency rates of human, dog and livestock population respectively so that $\frac{1}{\rho_i}$ where $i = h, d, l$ are the corresponding incubation periods.

2.2.3 Model Equations

Based on the assumptions and interrelation between the variables and parameters in Fig. 2.1, rabies transmission dynamics can be described by using ordinary differential equations.

$$\begin{aligned}
 \frac{dS_h}{dt} &= \mathcal{G}_h + \omega_h R_h - \beta_h I_d S_h - \mu_h S_h, \\
 \frac{dE_h}{dt} &= \beta_h I_d S_h - (\rho_h + \mu_h + \varphi_h) E_h, \\
 \frac{dI_h}{dt} &= \rho_h E_h - (\mu_h + \sigma_h) I_h, \\
 \frac{dR_h}{dt} &= \varphi_h E_h - (\omega_h + \mu_h) R_h.
 \end{aligned}
 \tag{2.1a}$$

Human

$$\begin{aligned}
 \frac{dS_d}{dt} &= \mathcal{G}_d + \omega_d R_d - (\mu_d + \varphi_d + \beta_d I_d) S_d, \\
 \frac{dE_d}{dt} &= \beta_d S_d I_d - (\rho_d + \mu_d) E_d, \\
 \frac{dI_d}{dt} &= \rho_d E_d - (\mu_d + \sigma_d) I_d, \\
 \frac{dR_d}{dt} &= \varphi_d S_d - (\mu_d + \omega_d) R_d.
 \end{aligned}
 \tag{2.1b}$$

Dog

$$\begin{aligned}
 \frac{dS_l}{dt} &= \mathcal{G}_l + \omega_l R_l - \beta_l I_d S_l - \mu_l S_l, \\
 \frac{dE_l}{dt} &= \beta_l I_d S_l - (\rho_l + \mu_l + \varphi_l) E_l, \\
 \frac{dI_l}{dt} &= \rho_l E_l - (\mu_l + \sigma_l) I_l, \\
 \frac{dR_l}{dt} &= \varphi_l E_l - (\omega_l + \mu_l) R_l.
 \end{aligned}
 \tag{2.1c}$$

Livestock

The total human, dog and livestock populations are $N_h(t)$, $N_d(t)$ and $N_l(t)$ given by

$$N_h(t) = S_h(t) + E_h(t) + I_h(t) + R_h(t),$$

$$N_d(t) = S_d(t) + E_d(t) + I_d(t) + R_d(t),$$

$$N_l(t) = S_l(t) + E_l(t) + I_l(t) + R_l(t).$$

Therefore adding each of the differential equations of system (2.1) of human, dog and livestock populations will give us:

$$\begin{aligned}
\frac{dN_h}{dt} &= \mathcal{G}_h - \mu_h N_h - \sigma_h I_h, \\
\frac{dN_d}{dt} &= \mathcal{G}_d - \mu_d N_d - \sigma_d I_d, \\
\frac{dN_l}{dt} &= \mathcal{G}_l - \mu_l N_l - \sigma_l I_l,
\end{aligned} \tag{2.2}$$

where N_i , $i = h, d, l$ is the total of human, dog and livestock populations at time t .

Invariant Region

The model system represented by (2.1) dealing with human, dog and livestock populations will be analyzed in the feasible region Φ , and all state variables and parameters are assumed to be positive for all $t \geq 0$. The invariant region will be obtained through Theorem 2.1.

Theorem 2.1:

All solutions of the system (2.1) are contained in the region $\Phi \in \mathbb{R}_+^{12}$ and $\Phi = \Phi_h \cup \Phi_d \cup \Phi_l \subset \mathbb{R}_+^4 \times \mathbb{R}_+^4 \times \mathbb{R}_+^4$,

where

$$\Phi_h = \{(S_h, E_h, I_h, R_h) \in \mathbb{R}_+^4 : 0 \leq N_h \leq \frac{\mathcal{G}_h}{\mu_h}\},$$

$$\Phi_d = \{(S_d, E_d, I_d, R_d) \in \mathbb{R}_+^4 : 0 \leq N_d \leq \frac{\mathcal{G}_d}{\mu_d}\},$$

$$\Phi_l = \{(S_l, E_l, I_l, R_l) \in \mathbb{R}_+^4 : 0 \leq N_l \leq \frac{\mathcal{G}_l}{\mu_l}\},$$

and Φ is the positive invariant region for system (2.1)

Proof:

From system (2.1a) the human population is $\frac{dN_h(t)}{dt} = \frac{S_h(t)}{dt} + \frac{E_h(t)}{dt} + \frac{I_h(t)}{dt} + \frac{R_h(t)}{dt}$.

Therefore the sum of total population of human will satisfy

$$\frac{dN_h}{dt} = \mathcal{G}_h - \mu_h N_h - \sigma_h I_h \text{ . as in (2.2)}$$

Thus

$$\frac{dN_h}{dt} \leq \mathcal{G}_h - \mu_h N_h ,$$

$$\frac{dN_h}{dt} + \mu_h N_h \leq \mathcal{G}_h .$$

This is a first order linear differential inequality with integrating factor $e^{\mu_h t}$

$$e^{\mu_h t} \frac{dN_h}{dt} + e^{\mu_h t} \mu_h N_h \leq e^{\mu_h t} \mathcal{G}_h ,$$

$$\frac{d}{dt} (N_h e^{\mu_h t}) \leq e^{\mu_h t} \mathcal{G}_h ,$$

$$N_h e^{\mu_h t} \leq \int e^{\mu_h t} \mathcal{G}_h dt ,$$

$$N_h e^{\mu_h t} \leq \frac{\mathcal{G}_h}{\mu_h} e^{\mu_h t} + c ,$$

$$N_h \leq \frac{\mathcal{G}_h}{\mu_h} + c e^{-\mu_h t} . \tag{2.3}$$

Applying initial conditions when $t = 0$

$$N_h(t=0) = N_h(0) ,$$

$$N_h(0) \leq \frac{\mathcal{G}_h}{\mu_h} + c ,$$

$$N_h(0) - \frac{\mathcal{G}_h}{\mu_h} \leq c .$$

Substituting this expression in (2.3) we get

$$N_h \leq \frac{\mathcal{G}_h}{\mu_h} + \left(N_h(0) - \frac{\mathcal{G}_h}{\mu_h} \right) e^{-\mu_h t} ,$$

as t gets bigger and bigger the expression $\left(N_h(0) - \frac{\mathcal{G}_h}{\mu_h} \right) e^{-\mu_h t}$ will be zero .

Thus we have

$$N_h(t) \leq \frac{\mathcal{G}_h}{\mu_h} + \left(N_h(0) - \frac{\mathcal{G}_h}{\mu_h} \right) e^{-\mu_h t} = N_h(t) \leq \frac{\mathcal{G}_h}{\mu_h} .$$

Therefore

$$0 \leq N_h(t) \leq \frac{\mathcal{G}_h}{\mu_h} . \text{ This is the boundary for human population.} \quad (2.4)$$

This implies that $N_h(t) \geq 0$ for all t .

Similarly, if we consider the total of dog and livestock populations of sub-systems (2.1b) and (2.1c) we get the same result as in (2.4). That is $N_d(t) \geq 0$ and $N_l(t) \geq 0$ hence the set

$\{(S_h, E_h, I_h, R_h \in \mathbb{R}_+^4), (S_d, E_d, I_d, R_d \in \mathbb{R}_+^4), (S_l, E_l, I_l, R_l \in \mathbb{R}_+^4)\}$ is positively invariant set in Φ .

Positivity of the solution

The model system (2.1) to be epidemiologically meaningful and well posed. We need to prove that all state variables are non-negative $\forall t \geq 0$.

Theorem 2.2:

Let $\{(S_h(0), S_d(0), S_l(0) > 0, I_h(0), I_d(0), I_l(0) > 0, R_h(0), R_d(0), R_l(0) > 0, E_h(0)E_d, E_l > 0\} \in \Phi$

Then the solution set $\{S_h(t), E_h(t), I_h(t), R_h(t), S_d(t), E_d(t), I_d(t), R_d(t), S_l(t), E_l(t), I_l(t), R_l(t)\}$ of the model system (2.1) is positive for all $t \geq 0$.

Proof.

From the first equation of (2.1a) we have:-

$$\frac{dS_h}{dt} = \mathcal{G}_h + \omega_h R_h - (\mu_h + \beta_h I_d) S_h .$$

This can be written as

$$\frac{dS_h}{dt} \geq -(\mu_h + \beta_h I_d) S_h ,$$

by rearranging we get

$$\frac{dS_h}{S_h} \geq -(\mu_h + \beta_h I_d) dt ,$$

in the absence of disease

$$\frac{dS_h}{S_h} \geq -\mu_h dt ,$$

Integrating both sides

$$\int \frac{1}{S_h} dS_h \geq -\int \mu_h dt ,$$

$$\ln S_h \geq -\mu_h t ,$$

$S_h \geq S_h(0)e^{-\mu_h t} > 0$ we have shown that S_h is positive for $\forall t > 0$.

Using a similar process

$$E_h \geq E_h(0)e^{-(\rho_h + \mu_h + \phi_h)t} > 0 , \forall t > 0 ,$$

$$I_h \geq I_h(0)e^{-(\mu_h + \sigma_h)t} > 0 , \forall t > 0 ,$$

$$R_h \geq R_h(0)e^{-(\mu_h + \omega_h)t} > 0 , \forall t > 0 ,$$

$$S_d \geq S_d(0)e^{-(\phi_d + \mu_d)t} > 0 , \forall t > 0 ,$$

$$E_d \geq E_d(0)e^{-(\rho_d + \mu_d)t} > 0 , \forall t > 0 ,$$

$$I_d \geq I_d(0)e^{-(\mu_d + \sigma_d)t} > 0 , \forall t > 0 ,$$

$$R_d \geq R_d(0)e^{-(\mu_d + \omega_d)t} > 0 , \forall t > 0 ,$$

$$S_l \geq S_l(0)e^{-\mu_l t} > 0 , \forall t > 0 ,$$

$$E_l \geq E_l(0)e^{-(\rho_l + \mu_l + \phi_l)t} > 0 , \forall t > 0 ,$$

$$I_l \geq I_l(0)e^{-(\mu_l + \sigma_l)t} > 0, \forall t > 0,$$

$$R_l \geq R_l(0)e^{-(\mu_l + \omega_l)t} > 0, \forall t > 0.$$

Therefore the solution set

$\{S_h(t), E_h(t), I_h(t), R_h(t), S_d(t), E_d(t), I_d(t), R_d(t), S_l(t), E_l(t), I_l(t), R_l(t)\} \in \mathbb{R}^{12}$ of the model is positive $\forall t > 0$.

2.3 Model Analysis

2.3.1 Disease Free Equilibrium Points (DFE)

To find the disease free equilibrium points we set the right hand side of equations of system 2.1 equal to zero. In the absence of attack or in the absence of rabies the following compartments will be zero.

$$E_h = R_h = I_h = E_d = I_d = E_l = R_l = I_l = 0$$

then the disease free equilibrium (DFE) ε_0 will be

$$\varepsilon_0 = (S_h^0, 0, 0, 0, S_d^0, 0, 0, R_d^0, S_l^0, 0, 0, 0),$$

$$\text{where } S_h^0 = \frac{\mathcal{G}_h}{\mu_h}, S_d^0 = \frac{\mathcal{G}_d(\mu_d + \omega_d)}{\mu_d(\mu_d + \varphi_d + \omega_d)}, R_d^0 = \frac{\varphi_d \mathcal{G}_d}{\mu_d(\mu_d + \varphi_d + \omega_d)} \text{ and } S_l^0 = \frac{\mathcal{G}_l}{\mu_l}.$$

For the dog population in the case of disease free equilibrium points R_d cannot be zero because susceptible dogs which are vaccinated transfer to recovered class. Therefore the disease free equilibrium points of system (2.1) exists and is given by:

$$\varepsilon_0 = \left(\frac{\mathcal{G}_h}{\mu_h}, 0, 0, 0, \frac{\mathcal{G}_d(\mu_d + \omega_d)}{\mu_d(\mu_d + \varphi_d + \omega_d)}, 0, 0, \frac{\varphi_d \mathcal{G}_d}{\mu_d(\mu_d + \varphi_d + \omega_d)}, \frac{\mathcal{G}_l}{\mu_l}, 0, 0, 0 \right). \quad (2.5)$$

2.3.2 The Basic Reproduction Number, R_0

The basic reproduction number R_0 is a threshold parameter defined as the average number of secondary infection caused by an infectious individual by introducing in to a completely susceptible population. It is also called the basic reproduction ratio or basic reproductive rate (Hethcote, 2000). Basic reproduction number is very important parameter which helps to

determine whether the disease spreads in the population or it dies out. If $R_0 < 1$, then on average an infected individual produces less than one new infected individual over the course of its infectious period, and the infection cannot grow. Conversely, if $R_0 > 1$ then each infected individual produces, on average, more than one new infection, and the disease can invade the population. It is also crucial in the process of analyzing sensitive parameters which drive the dynamics of the disease and stability analysis of disease free and endemic equilibrium points.

To compute the basic reproduction number, it is important to identify new infections from all other changes in the population. We used next generation operator method proposed by Van den Driessche & Watmough (2000). We considered system (2.1) without vaccination i.e. $\omega = \varphi = 0$.

Let $f_i(x)$ be the rate of appearance of new infection in compartment i , $v_i^-(x)$ be the rate of transfer of individuals out of compartment i and $v_i^+(x)$ be the rate of transfer of individuals into compartment i by all other means, and it is assumed that each function is continuously differentiable at least twice in each variable. The disease transmission model of system (2.1) consists of nonnegative initial conditions together with the following system of equations:

$$\dot{x} = \mathcal{F}_i(x) = f_i(x) - v_i(x), \quad i=1, \dots, 6, \quad (2.6)$$

where $v_i = v_i^- - v_i^+$.

We consider expressions in which the infection is in progression. These are

E_h, I_h, E_d, I_d, E_l and I_l .

$$\begin{aligned} \frac{dE_h}{dt} &= \beta_h S_h I_d - (\rho_h + \mu_h) E_h, \\ \frac{dI_h}{dt} &= \rho_h E_h - (\mu_h + \sigma_h) I_h, \\ \frac{dE_d}{dt} &= \beta_d S_d I_d - (\rho_d + \mu_d) E_d, \\ \frac{dI_d}{dt} &= \rho_d E_d - (\mu_d + \sigma_d) I_d, \\ \frac{dE_l}{dt} &= \beta_l S_l I_d - (\rho_l + \mu_l) E_l, \\ \frac{dI_l}{dt} &= \rho_l E_l - (\mu_l + \sigma_l) I_l. \end{aligned} \quad (2.7)$$

By rearranging equations of system (2.1) without vaccination from infected to infectious class of human dog and livestock populations with a system of equations given by (2.7)

Let F be a non-negative $n \times n$ matrix and V be a non-singular N-matrix such that

$$F = \left[\frac{\partial f_i(\varepsilon_0)}{x_j} \right] \quad \text{and} \quad V = \left[\frac{\partial v_i(\varepsilon_0)}{x_j} \right] \quad \text{with } 1 \leq i, j \leq n.$$

The point ε_0 is the disease free equilibrium point in (2.5) without vaccination.

where

$$f_i = \begin{bmatrix} f_1 \\ f_2 \\ f_3 \\ f_4 \\ f_5 \\ f_6 \end{bmatrix} = \begin{bmatrix} \beta_h S_h I_d \\ 0 \\ \beta_d S_d I_d \\ 0 \\ \beta_l S_l I_d \\ 0 \end{bmatrix}, \quad (2.8)$$

$$v = \begin{bmatrix} v_1 \\ v_2 \\ v_3 \\ v_4 \\ v_5 \\ v_6 \end{bmatrix} = \begin{bmatrix} (\rho_h + \mu_h) E_h \\ (\mu_h + \sigma_h) I_h - \rho_h E_h \\ (\rho_d + \mu_d) E_d \\ (\mu_d + \sigma_d) I_d - \rho_d E_d \\ (\rho_l + \mu_l) E_l \\ (\mu_l + \sigma_l) I_l - \rho_l E_l \end{bmatrix}. \quad (2.9)$$

By considering the classes in which infection is on progression and using the linearization technique. The Jacobean matrices of f and v at the disease free equilibrium point ε_0 are given by:

$$F = \frac{\partial f_i(\varepsilon_0)}{x_j} = \begin{bmatrix} 0 & 0 & 0 & \frac{\beta_h \mathcal{G}_h}{\mu_h} & 0 & 0 \\ 0 & 0 & 0 & 0 & 0 & 0 \\ 0 & 0 & 0 & \frac{\beta_d \mathcal{G}_d}{\mu_d} & 0 & 0 \\ 0 & 0 & 0 & 0 & 0 & 0 \\ 0 & 0 & 0 & \frac{\beta_l \mathcal{G}_l}{\mu_l} & 0 & 0 \\ 0 & 0 & 0 & 0 & 0 & 0 \end{bmatrix}, \quad (2.10)$$

$$V = \frac{\partial v_i(\varepsilon_0)}{\partial x_j} = \begin{bmatrix} \rho_h + \mu_h & 0 & 0 & 0 & 0 & 0 \\ -\rho_h & \mu_h + \sigma_h & 0 & 0 & 0 & 0 \\ 0 & 0 & \rho_d + \mu_d & 0 & 0 & 0 \\ 0 & 0 & -\rho_d & \mu_d + \sigma_d & 0 & 0 \\ 0 & 0 & 0 & 0 & \rho_l + \mu_l & 0 \\ 0 & 0 & 0 & 0 & -\rho_l & \mu_l + \sigma_l \end{bmatrix}. \quad (2.11)$$

Solving for V^{-1} and multiplying it with F gives us a matrix $FV^{-1} = \left[\frac{\partial f_i(\varepsilon_0)}{x_j} \right] \left[\frac{\partial v_i(\varepsilon_0)}{x_j} \right]^{-1}$.

Choosing the maximum eigenvalue in absolute terms that is the spectral radius of the matrix FV^{-1} gives us the basic reproduction number which is given by:

$$R_0 = \frac{\rho_d \beta_d \mathcal{G}_d}{\mu_d (\rho_d + \mu_d) (\mu_d + \sigma_d)}. \quad (2.12)$$

In our assumption there is no secondary infection in human and livestock population, due to this all the parameters of R_0 in (2.12) are depending on dog population. This shows that targeting dog population in the process of combating rabies transmission is very important. Providing PEP for human or livestock population does not eradicate the disease from the community.

2.3.3 The Effective Reproduction Number, R_e

The effective reproduction number is defined as the measure of average number of infections caused by a single infectious individual introduced in a community in which intervention strategies (in our case vaccination) is administered. The effective reproduction number R_e of system (2.1) is computed by applying the same procedure of R_0 . The spectral radius (dominant eigenvalue) of FV^{-1} denoted by $R_e = \rho(FV^{-1})$.

$$R_e = \frac{\rho_d \beta_d \mathcal{G}_d (\mu_d + \omega_d)}{\mu_d (\mu_d + \varphi_d + \omega_d) (\rho_d + \mu_d) (\mu_d + \sigma_d)}. \quad (2.13)$$

$$\text{Since } R_0 = \frac{\rho_d \beta_d \mathcal{G}_d}{\mu_d(\rho_d + \mu_d)(\mu_d + \sigma_d)},$$

we can express R_e in terms of R_0 as

$$R_e = \frac{(\mu_d + \omega_d)}{(\mu_d + \varphi_d + \omega_d)} R_0. \quad (2.14)$$

Numerical computation of R_0 , and R_e was done using the parameter values which are given in Table 3.1. Estimations of the model parameters and reasons are given in section 3.3. We substitute the parameter values in to the expressions in (2.12) and (2.13) respectively.

$$R_0 = \frac{(0.17)(1.29 \times 10^{-5})(2 \times 10^4)}{0.083(0.17 + 0.083)(0.083 + 1)} \approx 2$$

Without any control measure the result of R_0 is greater than one, which shows that the disease will continue spreading in the population.

$$R_e = \frac{(0.17)(1.29 \times 10^{-5})(2 \times 10^4)(0.083 + 0.5)}{0.083(0.083 + 0.1 + 0.5)(0.17 + 0.083)(0.083 + 1)} \approx 1.6$$

With the current 10% vaccination coverage for dog population the result of R_e is greater than one which shows again the disease will persist in the community. The above results of R_e and R_0 tell us that more interventions should be taken to control the spread of rabies within and around Addis Ababa. The result of basic reproduction number is almost the same with (Zhang *et al.*, 2011) which was 2 for the transmission of rabies in china. Our result of effective reproduction number (with the current 10% vaccination coverage for dog population in and around Addis Ababa) is also approaching the basic reproduction number result of (Hou *et al.*, 2012) for the transmission of rabies in Guangdong province of China.

2.4 Stability Analysis

2.4.1 Local Stability of the Disease Free Equilibrium Points

In this sub-section we investigate the local stability of the disease free equilibrium points using the trace and determinant method using the Jacobean matrix of system (2.1) at DFE.

Theorem 2.3. If $R_e < 1$, then (a) the disease-free equilibrium \mathcal{E}_0 of system (2.1) is locally asymptotically stable; (b) the disease-free equilibrium \mathcal{E}_0 of system (2.1) is globally asymptotically stable in the region Φ .

Using the disease free equilibrium points in (2.5), we derive the Jacobean matrix of system (2.1) by differentiating each of the equation of system (2.1) in terms of state variables

$$S_h, E_h, I_h, R_h, S_d, E_d, I_d, R_d, S_l, E_l, I_l, R_l$$

$$J_{\mathcal{E}_0} = \begin{bmatrix} -\mu_h & 0 & 0 & \omega_h & 0 & 0 & \frac{-\beta_h \mathcal{G}_h}{\mu_h} & 0 & 0 & 0 & 0 & 0 & 0 \\ 0 & -(\mu_h + \rho_h + \varphi_h) & 0 & 0 & 0 & 0 & \frac{\beta_h \mathcal{G}_h}{\mu_h} & 0 & 0 & 0 & 0 & 0 & 0 \\ 0 & \rho_h & -(\mu_h + \sigma_h) & 0 & 0 & 0 & 0 & 0 & 0 & 0 & 0 & 0 & 0 \\ 0 & \varphi_h & 0 & -(\omega_h + \mu_h) & 0 & 0 & 0 & 0 & 0 & 0 & 0 & 0 & 0 \\ 0 & 0 & 0 & 0 & -(\mu_d + \varphi_d) & 0 & \frac{-\beta_d \mathcal{G}_d (\mu_d + \omega_d)}{\mu_d (\mu_d + \varphi_d + \omega_d)} & \omega_d & 0 & 0 & 0 & 0 & 0 \\ 0 & 0 & 0 & 0 & 0 & -(\mu_d + \rho_d) & \frac{\beta_d \mathcal{G}_d (\mu_d + \omega_d)}{\mu_d (\mu_d + \varphi_d + \omega_d)} & 0 & 0 & 0 & 0 & 0 & 0 \\ 0 & 0 & 0 & 0 & 0 & \rho_d & -(\mu_d + \sigma_d) & 0 & 0 & 0 & 0 & 0 & 0 \\ 0 & 0 & 0 & 0 & \varphi_d & 0 & 0 & -(\mu_d + \omega_d) & 0 & 0 & 0 & 0 & 0 \\ 0 & 0 & 0 & 0 & 0 & 0 & \frac{-\beta_l \mathcal{G}_l}{\mu_l} & 0 & -\mu_l & 0 & 0 & 0 & 0 \\ 0 & 0 & 0 & 0 & 0 & 0 & \frac{\beta_l \mathcal{G}_l}{\mu_l} & 0 & 0 & -(\mu_l + \rho_l + \varphi_l) & 0 & 0 & 0 \\ 0 & 0 & 0 & 0 & 0 & 0 & 0 & 0 & 0 & \rho_l & -(\mu_l + \sigma_l) & 0 & 0 \\ 0 & 0 & 0 & 0 & 0 & 0 & 0 & 0 & 0 & \varphi_l & 0 & 0 & -(\mu_l + \omega_l) \end{bmatrix}$$

Then we find the trace of matrix $J_{\mathcal{E}_0}$

The trace of an n – by – n square matrix A is defined to be the sum of the elements in the main diagonal of A , i.e.,

$$\text{Tr}(A) = a_{11} + a_{22} + \dots + a_{nn} = \sum_{i=1}^n a_{ii}, \quad \text{where } a_{nn} \text{ denotes the entry on the } n\text{-th row and } n\text{-th column of } A.$$

Therefore

$$\begin{aligned} \text{Tr}(J_{\mathcal{E}_0}) &= -\mu_h - (\mu_h + \rho_h + \varphi_h) - (\mu_h + \sigma_h) - (\omega_h + \mu_h) - (\mu_d + \varphi_d) - (\mu_d + \rho_d) - \\ &\quad (\mu_d + \sigma_d) - (\mu_d + \omega_d) - \mu_l - (\mu_l + \rho_l + \varphi_l) - (\mu_l + \sigma_l) - (\mu_l + \omega_l) \\ &= -4\mu_d - 4\mu_h - 4\mu_l - \rho_d - \rho_h - \rho_l - \sigma_d - \sigma_h - \sigma_l - \phi_d - \phi_h - \phi_l - \omega_d - \omega_h - \omega_l \end{aligned}$$

Since we have assumed that all parameters of the model are positive then $\text{Tr}(J_{\mathcal{E}_0}) < 0$

To find the determinant of the Jacobean matrix at the disease free equilibrium points we used Mathematica software and simplify fully to get the following expression.

$$Det(J_{\varepsilon_0}) = \mu_d \mu_h \mu_l (-\beta_d \rho_d S_d + (\mu_d + \rho_d)(\mu_d + \sigma_d))(\mu_h + \sigma_h)(\mu_l + \sigma_l) \times (\mu_h + \rho_h + \varphi_h)(\mu_l + \omega_l)(\mu_l + \rho_l + \varphi_l)(\mu_d + \varphi_d + \omega_d)(\mu_h + \omega_h)$$

but from our disease free equilibrium point $S_d = \frac{\mathcal{G}_d(\mu_d + \omega_d)}{\mu_d(\mu_d + \varphi_d + \omega_d)}$ substitute this value to the above expression

$$Det(J_{\varepsilon_0}) = \mu_d \mu_h \mu_l (-\beta_d \rho_d \frac{\mathcal{G}_d(\mu_d + \omega_d)}{\mu_d(\mu_d + \varphi_d + \omega_d)} + (\mu_d + \rho_d)(\mu_d + \sigma_d))(\mu_h + \sigma_h) \times (\mu_l + \sigma_l)(\mu_h + \rho_h + \varphi_h)(\mu_l + \omega_l)(\mu_l + \rho_l + \varphi_l)(\mu_d + \varphi_d + \omega_d)(\mu_h + \omega_h)$$

$$\text{Since } R_e = \frac{\rho_d \beta_d \mathcal{G}_d(\mu_d + \omega_d)}{\mu_d(\mu_d + \varphi_d + \omega_d)(\rho_d + \mu_d)(\mu_d + \sigma_d)},$$

simple computation makes the following two expression to be equal

$$(-\beta_d \rho_d \frac{\mathcal{G}_d(\mu_d + \omega_d)}{\mu_d(\mu_d + \varphi_d + \omega_d)} + (\mu_d + \rho_d)(\mu_d + \sigma_d)) = (1 - R_e)(\mu_d + \rho_d)(\mu_d + \sigma_d)$$

therefore

$$Det(J_{\varepsilon_0}) = \mu_d \mu_h \mu_l (1 - R_e)(\mu_d + \rho_d)(\mu_d + \sigma_d)(\mu_h + \sigma_h)(\mu_l + \sigma_l)(\mu_h + \rho_h + \varphi_h) \times (\mu_l + \varphi_l)(\mu_l + \rho_l + \varphi_l)(\mu_d + \varphi_d + \omega_d)(\mu_h + \omega_h)$$

Thus for $R_e < 1$, we have

$Tr(J_{\varepsilon}) < 0$ and $Det(J_{\varepsilon_0}) > 0$. Then the DFE is locally asymptotically stable otherwise

it is unstable if $R_e > 1$.

2.4.2 Global Stability of Disease Free Equilibrium Points

To investigate the global stability of disease free equilibrium point of system (2.1) we used the method proposed by (Iggidr *et al.*, 2007).

We write our system as follows:

$$\begin{cases} \frac{dX_n}{dt} = A(X_n - X_{E_0,n}) + A_1 X_i, \\ \frac{dX_i}{dt} = A_2 X_i, \end{cases} \quad (2.15)$$

in which X_n and X_i are vectors corresponding to the transmitting and non-transmitting compartments, and $X_{E_0,n}$ is vector at disease free equilibrium point E_0 of the same vector length as X_n .

Referring to system (2.1) we define

$$X_n = (S_h, R_h, S_d, R_d, S_l, R_l)^T, \quad X_i = (E_h, I_h, E_d, I_d, E_l, I_l)^T,$$

$$X_{E_0,n} = \left(\frac{\mathcal{G}_h}{\mu_h}, 0, \frac{\mathcal{G}_d(\mu_d + \omega_d)}{\mu_d(\mu_d + \varphi_d + \omega_d)}, \frac{\varphi_d \mathcal{G}_d}{\mu_d(\mu_d + \varphi_d + \omega_d)}, \frac{\mathcal{G}_l}{\mu_l}, 0 \right)^T,$$

$$X_n - X_{E_0,n} = \begin{bmatrix} S_h - \frac{\mathcal{G}_h}{\mu_h} \\ R_h \\ S_d - \frac{\mathcal{G}_d(\mu_d + \omega_d)}{\mu_d(\mu_d + \varphi_d + \omega_d)} \\ R_d - \frac{\varphi_d \mathcal{G}_d}{\mu_d(\mu_d + \varphi_d + \omega_d)} \\ S_l - \frac{\mathcal{G}_h}{\mu_h} \\ R_l \end{bmatrix}.$$

For the global stability of DFE we need to prove the following.

- i) A should be a matrix with real negative eigenvalues
- ii) A_2 should be a Metzler matrix

Using system (2.1) together with the representation in (2.15) the two equation can be written as follows:

$$\begin{bmatrix} \mathcal{G}_h + \omega_h R_h - \beta_h I_d S_h - \mu_h S_h \\ \varphi_h E_h - (\omega_h + \mu_h) R_h \\ \mathcal{G}_d + \omega_d R_d - (\mu_d + \varphi_d + \beta_d I_d) S_d \\ \varphi_d S_d - (\mu_d + \omega_d) R_d \\ \mathcal{G}_l + \omega_l R_l - \beta_l I_d S_l - \mu_l S_l \\ \varphi_l E_l - (\omega_l + \mu_l) R_l \end{bmatrix} = A \begin{bmatrix} S_h - \frac{\mathcal{G}_h}{\mu_h} \\ R_h \\ S_d - \frac{\mathcal{G}_d(\mu_d + \omega_d)}{\mu_d(\mu_d + \varphi_d + \omega_d)} \\ R_d - \frac{\varphi_d \mathcal{G}_d}{\mu_d(\mu_d + \varphi_d + \omega_d)} \\ S_l - \frac{\mathcal{G}_h}{\mu_h} \\ R_l \end{bmatrix} + A_1 \begin{bmatrix} E_h \\ I_h \\ E_d \\ I_d \\ E_l \\ I_l \end{bmatrix},$$

$$\begin{bmatrix} \beta_d S_d I_d - (\rho_d + \mu_d) E_d \\ \rho_d E_d - (\mu_d + \sigma_d) I_d \\ \beta_d S_d I_d - (\rho_d + \mu_d) E_d \\ \rho_d E_d - (\mu_d + \sigma_d) I_d \\ \beta_l I_d S_l - (\rho_l + \mu_l + \varphi_l) E_l \\ \rho_l E_l - (\mu_l + \sigma_l) I_l \end{bmatrix} = A_2 \begin{bmatrix} E_h \\ I_h \\ E_d \\ I_d \\ E_l \\ I_l \end{bmatrix}.$$

Matrices A , A_1 and A_2 are of order 6×6

Using non-transmitting elements of the Jacobian matrix of system (2.1) and representation in (2.15) we get.

$$A = \begin{bmatrix} -\mu_h & \omega_h & 0 & 0 & 0 & 0 \\ 0 & -(\mu_h + \omega_h) & 0 & 0 & 0 & 0 \\ 0 & 0 & -(\varphi_d + \mu_d) & \omega_d & 0 & 0 \\ 0 & 0 & 0 & -(\mu_d + \omega_d) & 0 & 0 \\ 0 & 0 & 0 & 0 & -\mu_l & \omega_l \\ 0 & 0 & 0 & 0 & 0 & -(\omega_l + \mu_l) \end{bmatrix}, \quad (2.16)$$

$$A_1 = \begin{bmatrix} 0 & 0 & 0 & -\beta S_h & 0 & 0 \\ \varphi_h & 0 & 0 & 0 & 0 & 0 \\ 0 & 0 & 0 & -\beta_d S_d & 0 & 0 \\ 0 & 0 & 0 & 0 & 0 & 0 \\ 0 & 0 & 0 & -\beta_l S_l & 0 & 0 \\ 0 & 0 & 0 & 0 & \varphi_l & 0 \end{bmatrix}, \quad (2.17)$$

$$A_2 = \begin{bmatrix} -(\varphi_h + \mu_h + \rho_h) & 0 & 0 & \beta_h S_h & 0 & 0 \\ \rho_h & -(\mu_h + \sigma_h) & 0 & 0 & 0 & 0 \\ 0 & 0 & -(\rho_d + \mu_d) & \beta_d S_d & 0 & 0 \\ 0 & 0 & \rho_d & -(\mu_d + \sigma_d) & 0 & 0 \\ 0 & 0 & 0 & \beta_l S_l & -(\rho_l + \mu_l + \varphi_l) & 0 \\ 0 & 0 & 0 & 0 & \rho_l & -(\mu_l + \sigma_l) \end{bmatrix}. \quad (2.18)$$

We have seen that Matrix A is upper triangular whose eigenvalues are located on its main diagonal which are real and negative $-\mu_h, -(\mu_h + \omega_h), -(\varphi_d + \mu_d), -(\mu_d + \omega_d), -\mu_l, -(\omega_l + \mu_l)$. The off diagonal elements of matrix A_2 are non-negative (since all parameters are positive) which is Metzler matrix. This proves that the DFE point of system (2.1) globally asymptotically stable in the region Φ . This leads us to the following important theorem.

Theorem 2. 4. The disease-free equilibrium point is globally asymptotically stable in the region Φ if $R_e < 1$ and unstable if $R_e > 1$.

2.5 Endemic Equilibrium Points

2.5.1 Existence of Endemic Equilibrium Points

To find the equilibrium points of system (2.1) we set the right hand side of the equation equal to zero. The endemic equilibrium points of system (2.1), when they exist are given by:

$$\varepsilon_0^* = (S_h^*, E_h^*, I_h^*, R_h^*, S_d^*, E_d^*, I_d^*, R_d^*, S_l^*, E_l^*, I_l^*, R_l^*),$$

where

$$\left. \begin{aligned} S_h^* &= \frac{\mathcal{G}_h(\mu_h + \omega_h) + [(\omega_h \varphi_h - (\mu_h + \rho_h + \varphi_h)(\mu_h + \omega_h))]}{\mu_h(\mu_h + \omega_h)} E_h^*, \\ E_h^* &= \frac{\beta_h \mathcal{G}_h(\mu_h + \omega_h) I_d^*}{(\mu_h + \omega_h)[\mu_h(\mu_h + \varphi_h + \rho_h) + \beta_h I_d^*(\mu_h + \varphi_h + \rho_h)] - \beta_h \omega_h \varphi_h I_d^*}, \\ I_h^* &= \frac{\rho_h E_h^*}{\mu_h + \sigma_h}, & R_h^* &= \frac{\varphi_h E_h^*}{\mu_h + \omega_h}. \end{aligned} \right\}$$

$$\left. \begin{aligned} S_d^* &= \frac{(\rho_d + \mu_d)(\sigma_d + \mu_d)}{\beta_d \rho_d}, & E_d^* &= \frac{(\sigma_d + \mu_d)}{\rho_d} I_d^*, \\ I_d^* &= \frac{\mathcal{G}_d - \mu_d N_d^*}{\sigma_d}, & R_d^* &= \frac{\varphi_d(\rho_d + \mu_d)(\sigma_d + \mu_d)}{\beta_d \rho_d(\mu_d + \omega_d)}. \end{aligned} \right\} \quad (2.19)$$

$$\left. \begin{aligned} S_l^* &= \frac{\mathcal{G}_l(\mu_l + \omega_l) + [(\omega_l \varphi_l - (\mu_l + \rho_l + \varphi_l)(\mu_l + \omega_l))]}{\mu_l(\mu_l + \omega_l)} E_l^*, \\ E_l^* &= \frac{\beta_l \mathcal{G}_l(\mu_l + \omega_l) I_d^*}{(\mu_l + \omega_l)[\mu_l(\mu_l + \varphi_l + \rho_l) + \beta_l I_d^*(\mu_l + \varphi_l + \rho_l)] - \beta_l \omega_l \varphi_l I_d^*}, \\ I_l^* &= \frac{\rho_l E_l^*}{\mu_l + \sigma_l}, & R_l^* &= \frac{\varphi_l E_l^*}{\mu_l + \omega_l}. \end{aligned} \right\}$$

In which

$$I_d^* = \frac{\mathcal{G}_d \beta_d \rho_d (\mu_d + \omega_d) + \mu_d (\mu_d + \rho_d) (\mu_d + \sigma_d) (\mu_d + \varphi_d + \omega_d)}{\beta_d (\mu_d + \omega_d) (\mu_d + \rho_d) (\mu_d + \sigma_d)}.$$

2.5.2 Local Stability of the Endemic Equilibrium Points

To show the local stability of the endemic equilibrium points of system (2.1) we have used the following theorem as in (Parks, 1962).

Theorem 2.5 (Routh-Hurwitz Criteria) Given a polynomial

$$p(\lambda) = \lambda^n + a_1\lambda^{n-1} + \dots + a_{n-1}\lambda + a_n,$$

where the coefficients a_i are real constants, $i = 1, \dots, n$ define the n Hurwitz matrices using the coefficients a_i of the characteristic polynomial:

$$H_1 = (a_1), \quad H_2 = \begin{pmatrix} a_1 & 1 \\ a_3 & a_2 \end{pmatrix}, \quad H_3 = \begin{pmatrix} a_1 & 1 & 0 \\ a_3 & a_2 & a_1 \\ a_5 & a_4 & a_3 \end{pmatrix},$$

$$\text{and } H_n = \begin{pmatrix} a_1 & 1 & 0 & 0 & \dots & 0 \\ a_3 & a_2 & a_1 & 1 & \dots & 0 \\ a_5 & a_4 & a_3 & a_2 & \dots & 0 \\ \vdots & \vdots & \vdots & \vdots & \dots & \vdots \\ 0 & 0 & 0 & 0 & \dots & a_n \end{pmatrix},$$

where $a_i = 0$ if $j > n$. All of the roots of the polynomial $p(\lambda)$ are negative or have negative real part iff the determinants of all Hurwitz matrices are positive:

$$\det H_j > 0, \quad j = 0, 1, 2, \dots, n.$$

Details in Routh-Hurwitz criteria are given by (Parks, 1962; Sivanandam & Deepa, 2007).

Now consider system (2.1a) as it is independent of (2.1b) and (2.1c). The Jacobian matrix of system (2.1a) is given by:

$$J|_{\epsilon_*} = \begin{bmatrix} -\mu_h - \beta_h I_d^* & 0 & 0 & \omega_h \\ \beta_h I_d^* & -\mu_h - \varphi_h - \rho_h & 0 & 0 \\ 0 & \rho_h & -\mu_h - \sigma_h & 0 \\ 0 & \varphi_h & 0 & -\mu_h - \omega_h \end{bmatrix}. \quad (2.20)$$

By eliminating the third row and third column a 3×3 matrix can be generated from 2.20.

$$\begin{bmatrix} -\mu_h - \beta_h I_d^* & 0 & \omega_h \\ \beta_h I_d^* & -\mu_h - \varphi_h - \rho_h & 0 \\ 0 & \varphi_h & -\mu_h - \omega_h \end{bmatrix}$$

through computation, we derive the characteristic polynomial

$$p(\lambda) = \lambda^3 + (a+b+c)\lambda^2 + (ab+ac+bc)\lambda + (abc - \beta_h I_d^* \varphi_h \omega_h)$$

where $a = \mu_h + \beta_h I_d^*$, $b = \mu_h + \rho_h + \varphi_h$, $c = \mu_h + \omega_h$, the expressions for I_d^* and S_d^* are as in (2.19).

We now consider

$$p(\lambda) = \lambda^3 + A\lambda^2 + B\lambda + C \quad (2.21)$$

where

$$A = a+b+c, \quad B = ab+ac+bc, \quad C = abc - \beta_h I_d^* \varphi_h \omega_h$$

Using the characteristic polynomial representation in (2.21) the Hurwitz matrix is given by

$$H_4 = \begin{pmatrix} A & 1 & 0 \\ C & B & A \\ 0 & 0 & C \end{pmatrix}, \quad (2.22)$$

The determinant of the Hurwitz matrix is

$$ABC - C^2, \quad (2.23)$$

By Routh-Hurtwitz criteria of Theorem 2.5 the determinant of Hurtwiz matrix becomes positive if $A > 0$, $B > 0$, $C > 0$ and $AB > C$.

All parameters of our model are positive and the starred variables I_d^* and S_d^* are given by

(2.19). Therefore $A = a+b+c$ is greater than zero, $B = ab+ac+bc > 0$ and $C > 0$ if and

only if $abc > \beta_h I_d^* \varphi_h \omega_h$. When all the conditions for A , B and C hold, similarly using the

same procedure $AB > C$ holds. Hence all roots of the characteristic polynomial of (2.23) are

negative. This verifies that system (2.1a) is locally asymptotically stable.

Further we consider system (2.1b)

The Jacobean is given by

$$J|_{\epsilon^*} = \begin{bmatrix} -(\mu_d + \varphi_d + \beta_d I_d^*) & 0 & -\beta_d S_d^* & \omega_d \\ \beta_d I_d^* & -(\mu_d + \rho_d) & \beta_d S_d^* & 0 \\ 0 & \rho_d & -(\mu_d + \sigma_d) & 0 \\ \varphi_d & 0 & 0 & -(\mu_d + \omega_d) \end{bmatrix}. \quad (2.24)$$

through calculation we have come up with the following characteristic polynomial.

$$p_1(\lambda) = \lambda^4 + (a_1 + b_1 + c_1 + d_1)\lambda^3 + (a_1b_1 + a_1c_1 + a_1d_1 + b_1c_1 + b_1d_1 + c_1d_1 - \rho_d\beta_d S_d^* - \varphi_d\omega_d)\lambda^2 + (a_1c_1b_1 + a_1b_1d_1 + a_1c_1d_1 + b_1c_1d_1 + \beta_d^2 I_d^* \rho_d S_d^* - \varphi_d\omega_d b_1 - \varphi_d\omega_d c_1 - a_1\rho_d\beta_d S_d^* - d_1\rho_d\beta_d S_d^*)\lambda + (a_1b_1c_1d_1 + \varphi_d\rho_d\omega_d\beta_d S_d^* + \beta_d^2 I_d^* \rho_d S_d^* - a_1d_1\rho_d\beta_d S_d^* - \varphi_d\omega_d c_1 b_1)$$

where $a_1 = \mu_d + \varphi_d + \beta_d I_d^*$, $b_1 = \mu_d + \rho_d$, $c_1 = \mu_d + \sigma_d$, $d_1 = \mu_d + \omega_d$, and the expressions for I_d^* and S_d^* are as in (2.19).

Consider

$$p_1(\lambda) = \lambda^4 + A_1\lambda^3 + B_1\lambda^2 + C_1\lambda + D_1 \quad (2.25)$$

where

$$\begin{aligned} A_1 &= a_1 + b_1 + c_1 + d_1, & B_1 &= a_1b_1 + a_1c_1 + a_1d_1 + b_1c_1 + b_1d_1 + c_1d_1 - \rho_d\beta_d S_d^* - \varphi_d\omega_d, \\ C_1 &= a_1c_1b_1 + a_1b_1d_1 + a_1c_1d_1 + b_1c_1d_1 + \beta_d^2 I_d^* \rho_d S_d^* - \varphi_d\omega_d b_1 - \varphi_d\omega_d c_1 - a_1\rho_d\beta_d S_d^* - d_1\rho_d\beta_d S_d^*, \\ D_1 &= a_1b_1c_1d_1 + \varphi_d\rho_d\omega_d\beta_d S_d^* + \beta_d^2 I_d^* \rho_d S_d^* - a_1d_1\rho_d\beta_d S_d^* - \varphi_d\omega_d c_1 b_1. \end{aligned}$$

Using the characteristic polynomial representation in (2.25) the Hurwitz matrix is given by

$$H_4 = \begin{pmatrix} A_1 & 1 & 0 & 0 \\ C_1 & B_1 & A_1 & 1 \\ 0 & D_1 & C_1 & B_1 \\ 0 & 0 & 0 & D_1 \end{pmatrix}.$$

It follows that the determinant of H_4 is

$$-D_1(A_1^2 D_1 - A_1 B_1 C_1 + C_1^2). \quad (2.26)$$

By **Routh-Hurtwitz criteria of theorem 2.5** the determinant of Hurwitz matrix becomes positive if the following conditions hold.

$$A_1 > 0, \quad C_1 > 0, \quad D_1 > 0 \quad \text{and} \quad A_1 B_1 C_1 > C_1^2 + A_1^2 D_1,$$

Since all the parameters of our model are positive and the variables I_d^* and S_d^* are given by (2.19)

$A_1 = a_1 + b_1 + c_1 + d_1$ is greater than zero, $C_1 > 0$ if and only if

$$(a_1c_1b_1 + a_1b_1d_1 + a_1c_1d_1 + b_1c_1d_1 + \beta_d^2 I_d^* \rho_d S_d^*) > (\varphi_d\omega_d b_1 + \varphi_d\omega_d c_1 + a_1\rho_d\beta_d S_d^* + d_1\rho_d\beta_d S_d^*) \quad \text{and}$$

$D_1 > 0$ if and only if $(a_1 b_1 c_1 d_1 + \varphi_d \rho_d \omega_d \beta_d S_d + \beta_d^2 I_d^* \rho_d S_d^*) > (a_1 d_1 \rho_d \beta_d S_d^* + \varphi_d \omega_d c_1 b_1)$. When all the conditions for A_1 , C_1 and D_1 hold, similarly using the same procedure

$A_1 B_1 C_1 > C_1^2 + A_1^2 D_1$ holds. Hence all roots of the characteristic polynomial of (2.25) are negative, this verify that system (2.1b) is locally asymptotically stable.

Using the same procedure for (2.1c) gives the same proof. Therefore the endemic equilibrium point of system (2.1) is locally asymptotically stable.

2.6 Conclusion

Rabies is one of the infectious diseases that highly affect Addis Ababa and surrounding areas. The rate of the spread of the disease is alarming. To study the dynamics of the disease we have formulated and analyzed a deterministic mathematical model for the dynamics of rabies transmission. The model comprises dog, human and livestock populations. Since classical rabies is very common in dog populations, the model was intended to show rabies transmission among dogs and to humans and livestock in which the dog populations infect both humans and livestock.

The basic reproduction number and the effective reproduction number have been computed using next generation operator method. The results are entirely dependent on the parameters of the dog population. The dog populations are the source of infection for both human and livestock populations. It is assumed that there is no secondary infection in human and livestock populations due to rare cases. We found that control measures should focus on dog populations. Supplying PEP for humans can save exposed individuals, but cannot reduce the future rabies transmission.

The burden of rabies in and around Addis Ababa can be seen from the results of basic reproduction rate and effective reproduction rate. In developing countries like Asia and Africa the transmission of rabies has been increasing due to growth and urbanization. The number of dog populations are increasing in African cities from time to time. In 2009 the reproduction rate for African cities was estimated to be 1.2. In this study the basic reproduction rate for Addis Ababa and surrounding areas is found to be 2, which shows that rabies transmission in the city is above the average compared to other African countries. This result is the same with the reproduction rate in China which has high rabies transmission. This makes Ethiopia to be ranked one of the top countries highly affected by rabies.

CHAPTER THREE

Sensitivity Analysis and Numerical Simulations for the Mathematical Model of Rabies in Human and Animal Within and Around Addis Ababa²

Abstract: We propose a deterministic mathematical model to study the transmission dynamics of rabies within and around Addis Ababa. Sensitivity analysis of R_e is done using parameters of the model. The natural death rate of dogs μ_d , the annual birth rate of dogs ϑ_d , dog-to-dog transmission rate β_d , and disease induced death rate σ_d are found to be the most sensitive parameters of R_e . According to numerical simulations of our system with initial year 2008 rabies transmission will increase within and around Addis Ababa, and may peak in 2026 and 2033 in human and livestock populations respectively. Our simulation shows that 25% vaccination coverage in livestock populations will reduce the future infection by half. This study suggest that a combination of interventions consisting of 60% of vaccination coverage in dog populations, 15% culling of stray dogs, and reducing annual crop of newborn puppies by 25% will reduce the number of human and livestock infections by 70% .

Key Words: Rabies, Addis Ababa, Sensitivity analysis, Endemic, Reproduction number

3.1.Introduction

Rabies virus is *Lyssavirus* genus in the family of *Rhabdoviridae*. The virus has a shape resembling a bullet. After the virus enters the body through a skin opening, it travels to the spinal cord via the peripheral nervous system. Once the virus reaches the spinal cord it can easily travel to the brain and replicate itself there. It destroys the brain nerve cells and then disseminates to the salivary glands. It is unlikely for the infected individual to recover after symptoms start. Symptoms may include depression, profuse salivation, blindness, lack of appetite, difficulty in swallowing, eating and drinking, head-pressing, pacing, vocalization, fever, increased sexual excitement and activity, constant yawning and itching. The period of time before the individual exhibit symptoms, or incubation period, is usually one to three

²This chapter is based on published research paper:

Tesfaye Tadesse Ega, Livingstone S. Luboobi, Dmitry Kuznetsov and Abraham Haile Kidane. ‘Sensitivity Analysis and Numerical Simulations for the Mathematical Model of Rabies in Human and Animal Within and Around Addis Ababa’, Asian Journal of Mathematics and Applications, Volume 2015, Article ID ama0271, 23 pages, ISSN 2307-7743.

months, however it can vary from less than one week to more than one year depending on different factors. Factors include the distance from bite to brain, immune status, wound severity, wound site in relation to nerve supply, amount and strain of virus and protection provided by clothing (Addo, 2012).

Rabies is the most fatal of all zoonotic infectious diseases. Unfortunately awareness about the disease is low and it is often recognized as a public health issue in developing continents. Despite the interventions and scientific breakthroughs, rabies continues to be a dreadful communicable infectious disease. (Acha & Arambulo, 1985). More than 55 000 people die due to rabies per annum in more than 150 countries and territories. In low-income countries the rabies surveillance systems are often poor and underreporting occurs because of infected people dying at home. (Lembo *et la.*, 2015). More than 40% of the people who are bitten by infected (rabid) animals are children, which is explained by the higher tendency of children to play with animals. More than 15 million people receive post exposure vaccination worldwide (WHO, 2013).

Rabies is transmitted among animals and to humans through bites or scratches of a rabid animal. Many mammals can transmit the rabies virus, but in many parts of the world rabies is spread through infected domestic dogs. More than 3 billion people in developing countries are exposed to dog rabies (Khan, 2012). Dogs are the source for almost all types of human and livestock infection (Deressa *et al.*, 2010). Saliva from the infected dog can contaminate the paws, and hence a scratch is capable of transmitting the virus. A rabid dog may have bitten other animals such as another dog, cat, mule or cattle which can become rabid as well. Thus the infection is transmitted from animal to animal and the disease is perpetuated. The infected animal will demonstrate all symptoms of rabies and eventually die.

Rabies is highly endemic to Ethiopia. It was estimated that 10 000 people in Ethiopia die each year from rabies, making it one of the worst affected countries in the world. In most cases an individual who is bitten by a rabid dog goes to a traditional healer which interferes with timely seeking of post exposure prophylaxis (PEP). There is lack of accurate quantitative information on rabies both in human and animal populations. Further, low awareness is preventing people from applying effective control measures (Jemberu *et al.*, 2013).

In most cases rabies transmission is very high in urban places because of the high number of domestic dogs (Khan, 2012). The major cause of spread of rabies in these regions is urbanization. It is estimated that the dog to human population ratio in Ethiopia is 1:6 in urban

and 1:8 in rural areas. The number of dogs in Addis Ababa is estimated to be between 150 000 to 200 000 (Petros *et al.*, 2014). Despite vaccination and other control measures, rabies has persisted for centuries and it is reported from all regions of Ethiopia (Reta *et al.*, 2014). The first occurrence of rabies was recorded in August, 1903 in Addis Ababa, and it was known by its traditional name of *mad dog disease* (Pankhurst, 1970). Addis Ababa and its surroundings are the endemic parts of the country. It is reported that around 2000 people are bitten by dogs annually (Ali *et al.*, 2010). A retrospective record review of rabies deaths from 2001 to 2009 reports 386 total human deaths with an annual range of 35 to 58 deaths. From this, 42.72% were children under the age of 14 (Deressa *et al.*, 2010).

In Chapter two we developed a mathematical model for the transmission dynamics of rabies using ordinary differential equations. We have computed the effective reproduction and basic reproduction numbers, and performed the stability analysis of the model. In this chapter we perform numerical simulations of basic reproduction number and effective reproduction number. This is to analyze which control measures are more effective to reduce the value of R_e . For the purpose of identifying sensitive parameters and to predict the future status of rabies in human, dog and livestock populations we perform sensitivity analysis and numerical simulations of system (2.1) respectively.

From equations (2.12) and (2.13) the basic reproduction and effective reproduction numbers are given by:

$$R_0 = \frac{\rho_d \beta_d \mathcal{G}_d}{\mu_d (\rho_d + \mu_d) (\mu_d + \sigma_d)} \quad \text{and}$$

$$R_e = \frac{\rho_d \beta_d \mathcal{G}_d (\mu_d + \omega_d)}{\mu_d (\mu_d + \varphi_d + \omega_d) (\rho_d + \mu_d) (\mu_d + \sigma_d)} \quad \text{respectively.}$$

The simulation for the basic reproduction number shows that rabies transmission is very high without any intervention. We simulated the effective reproduction number with different vaccination coverages and a combination of interventions consisting of vaccination, culling and controlling the annual crop of newborn puppies. The results show that as we increase vaccination of the dog population there is a possibility for the disease to die out. The simulations show that a combination of interventions are the best way to reduce R_e to less than

unity. In Fig. 3.1, R_0 is without any vaccination, R_{e1} is the current 10% vaccination coverage, R_{e2} is 60% vaccination coverage, R_{e3} is 90% vaccination coverage and R_{e4} is combination of interventions consisting of 60% vaccination, 15% culling of stray dogs and reducing the annual crop of newborn puppies by 25% .

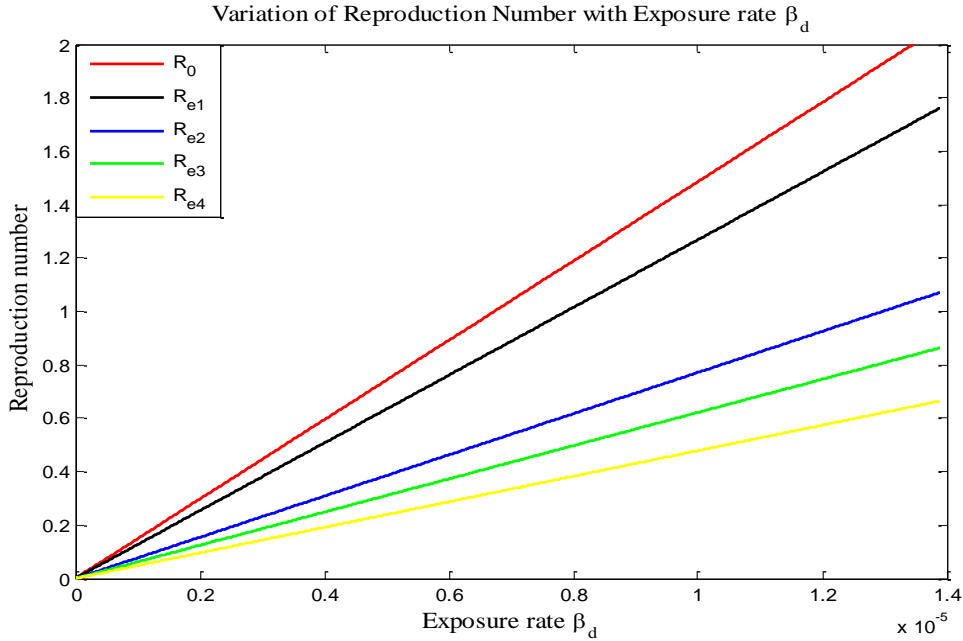

Figure 3.1: Reproduction number for different vaccination coverages and combination of vaccination, culling and controlling newborn puppies.

From Fig. 3.1 we observe that $R_{e4} < R_{e3} < R_{e2} < R_{e1} < R_0$, which shows that as we increase vaccination of dog populations the effective reproduction number decreases and becomes less than unity. It is very important to combine different interventions so as to facilitate the eradication of the disease form the community.

3.2. Sensitivity Analysis of R_e with Respect to the Model Parameters

The aim of any mathematical epidemiology study is to understand the dynamics of a disease so as to control it by targeting some sensitive parameters. This can be achieved by performing sensitivity analysis based on the model parameters. The parameters of our model are given with their descriptions in Table 3.1.

Sensitivity analysis tells us how each parameter of R_e affects its result. This will help to identify which parameters are most sensitive for the spread of the rabies virus, so that appropriate control measure can be taken (Chitnis *et al.*, 2008). Sensitivity analysis can be done

Table 3.1: The parameter values of the model

Parameter	Description	Value (Year ⁻¹)	Source
\mathcal{G}_h	Annual birth of humans	11 2980	Assumption
ω_h	Human loss of vaccination immunity	1	Zhang <i>et al.</i> , (2011)
ρ_h	Human incubation period	0.17	Zhang <i>et al.</i> , (2011)
μ_h	Natural death rate of humans	0.016	Assumption
β_h	Dog-to-human transmission rate	1.29×10^{-8}	Fitting
φ_h	Vaccination rate of humans	0.54	EPHI
σ_h	Disease related death rate of human	1	Assumption
\mathcal{G}_d	Annual birth of dogs	2×10^3	Fitting
ω_d	Loss of vaccination immunity of dog	0.5	Zhang <i>et al.</i> , (2011)
ρ_d	Incubation period of dogs	0.17	Zhang <i>et al.</i> , (2011)
μ_d	Natural death rate of dogs	0.083	Assumption
β_d	Dog-to-dog transmission rate	1.29×10^{-5}	Fitting
φ_d	Vaccination rate of dogs	0.1	Assumption
σ_d	Disease related death rate of dogs	1	Assumption
\mathcal{G}_l	Annual birth of livestock	2×10^5	Assumption
ω_l	Loss of vaccination immunity of livestock	0	EPHI
ρ_l	Livestock incubation period	0.17	Assumption
μ_l	Natural death rate of livestock	0.05	Assumption
β_l	Dog-to-livestock transmission rate	1.18×10^{-8}	Fitting
φ_l	Vaccination rate of livestock	0	EPHI
σ_l	Disease related death rate of livestock	1	Assumption

by computing the sensitivity indices of R_e . With small variation of the parameters it is important to identify which parameters greatly affect R_e .

The normalized forward sensitivity index is the ratio of relative change of a variable to the relative change in parameter. If the variable is a differentiable function of the parameter then the sensitivity index is defined as follows:

Definition 3.1: The normalized forward sensitivity index of variable g that depends on parameter b is defined as:

$$\gamma_b^g = \frac{\partial g}{\partial b} \times \frac{b}{g} . \quad (3.1)$$

Since we have computed the effective reproductive number, R_e , the normalized forward sensitivity with respect to the parameter b is given by:

$$\gamma_b^{R_e} = \frac{\partial R_e}{\partial b} \times \frac{b}{R_e} .$$

For example the sensitivity indices of R_e with respect to \mathcal{G}_d is given by:

$$\gamma_{\mathcal{G}_d}^{R_e} = \frac{\partial R_e}{\partial \mathcal{G}_d} \times \frac{\mathcal{G}_d}{R_e} = +1 . \quad (3.2)$$

By using the same notion, the sensitivity indices of the effective reproduction number given in expression 2.13 is computed with respect to all parameters embedded to R_e .

Table3. 2: Sensitivity indices of R_e

Parameter	Description	Value	Sensitivity Indices
μ_d	Natural death rate of dogs	0.083	-1.3781
\mathcal{G}_d	Annual birth of dogs	2×10^3	+1
β_d	Dog-to-dog transmission rate	1.29×10^{-5}	+1
σ_d	Disease related death rate of dogs	1	-0.9259
ρ_d	Dog incubation period	0.17	0.3243
φ_d	Vaccination rate of susceptible dogs	0.1	-0.1471
ω_d	Loss of vaccination immunity of dogs	0.5	0.1268

According to the sensitivity indices, the parameters of annual birth of dogs \mathcal{G}_d and dog-to-dog transmission rate β_d are the most positively sensitive parameters. This means increasing the parameters increase the effective reproduction number and vice versa. For instance increasing \mathcal{G}_d by 10% will increase R_e by 10%. Decreasing \mathcal{G}_d by 10% will decrease R_e by 10%. Dog

loss of vaccination immunity ω_d and dog incubation period ρ_d are less sensitive positive parameters.

Natural death rate of dog μ_d and disease related death rate σ_d are the most negatively sensitive parameters. Increasing the parameters which have negative signs will decrease the value of R_e and vice versa. For instance $\gamma_{\mu_d}^{R_e} = -1.3781$ means increasing the natural death rate of dogs by 15% will decrease R_e by 18%.

In summary, targeting the most positively and negatively sensitive parameters in the process of combating rabies will be most effective in reducing the transmission of the virus within and around Addis Ababa.

3.3. Numerical Results and Discussion

In this section we present the numerical simulations of system (2.1). We used ode45 MATLAB (Version 7.13.0.564 (R2011b)) standard solver for ordinary differential equations (ODEs). This function implements a Runge-Kutta method with a variable time step for efficient computation. In our simulation we need to estimate our parameters. The data for the number of infected human and livestock population from 2008 to 2014 were obtained from EPHI. Using the data we first simulated rabies fatal cases. The parameters like the annual birth of dog populations, dog-to-dog transmission, dog-to-human transmission and dog-to-livestock transmission rate were obtained by varying their values during simulations.

The number of dog populations within and around Addis Ababa are estimated to be between 230 000 and 300 000 of which 70% of them are stray dogs (Abraham *et al.*, 2012). In most cases the incubation period of rabies is one to three months. In our simulation we used two months by considering the average duration. According to the protection period of rabies vaccine, it is assumed that $\omega_h = \omega_d = 1$ (Zhang *et al.*, 2011). Life expectancy in Ethiopia is 63.0 for male and 66.4 for female, therefore by taking the average 64.7 the natural death rate of human is $\mu_h = 0.0016$. We used also 20 and 12 for life expectancy of livestock and dog respectively. The vaccination coverage for human and dog population is taken 60% and 10% respectively. Human vaccination coverage is obtained from EPHI, and for dog population we estimated 10% due to the high number of stray dogs, people awareness and high transmission of rabies in dog population. The efficiency of rabies vaccine is 90% therefore vaccination rate

for human and dog will be $\varphi_h = 0.6 \times 0.9 = 0.54$ and $\varphi_d = 0.1 \times 0.9 = 0.09 \approx 0.1$ respectively. We assume the probability of clinical outcome of the exposed is 40% in most cases it ranges between 30%-70%.

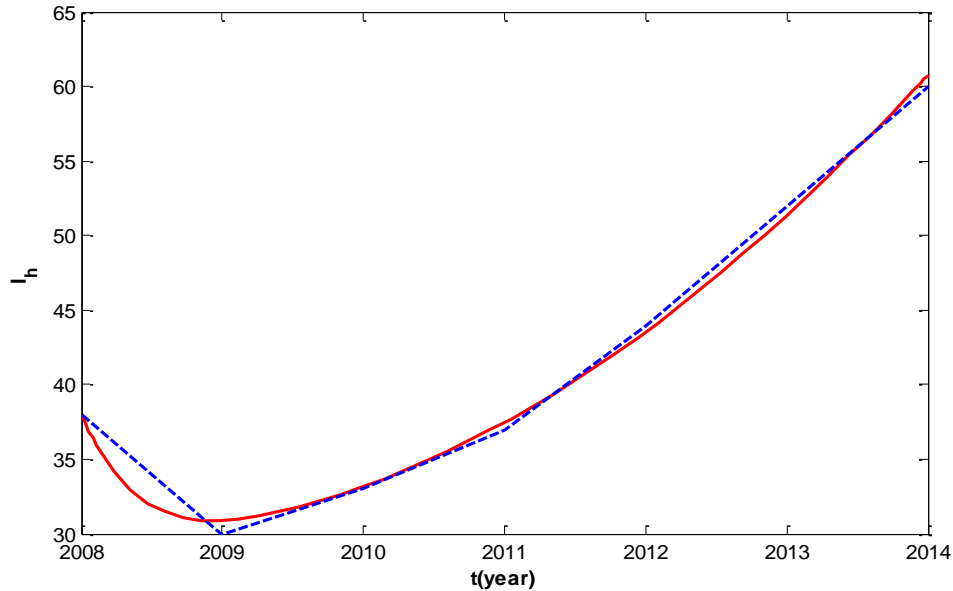

Figure 3.2: Comparison between reported data and simulation of system (2.1) for rabies infected humans in and around Addis Ababa from 2008 to 2014.

The broken curve represents the data which was reported from EPHI and the smooth curve is the simulation of the system (2.1) of infected human populations. There is a good match between our model and the reported data. Our simulation further predicts that human rabies will increase for the upcoming thirty four years. The simulations are based on parameters which are presented in Table 3.1. The initial values used in the simulations are $S_h(0) = 5 \times 10^6$, $E_h(0) = 100$, $I_h(0) = 38$, $R_h(0) = 2.5 \times 10^4$, $S_d(0) = 3 \times 10^5$, $E_d(0) = 8000$, $I_d(0) = 4000$, $R_d(0) = 5 \times 10^4$, $S_l(0) = 2.5 \times 10^5$, $E_l(0) = 50$, $I_l(0) = 5$, $R_l(0) = 0$.

In Fig. 3.3 the numerical result of the infected human population shows that the rabies virus will spread very rapidly in the coming years and it will peak in 2026. The bite of a rabid dog is the main reason for the transmission of rabies to humans. The increased number of dogs within and around Addis Ababa raises the number of stray dogs. Surveys indicate that in Addis Ababa, 1299 dog bites and/or scratches were reported in humans for the period September 2008 to August 2009. The majority of bites were made by stray dogs (Mengistu *et al.*, 2011). This

indicates that there is a need for stray dog control strategy to reduce the number of human infections.

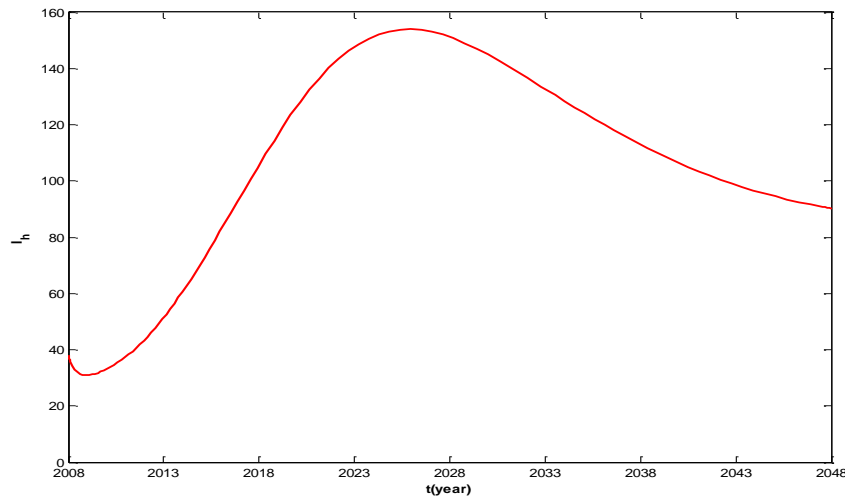

Figure 3.3: The dynamics of rabies in infected humans for the next 34 years in and around Addis Ababa.

From our sensitivity analysis, we found that annual dog birth is one of the sensitive parameters which controls the dynamics of the disease. A minor increase in newly born puppies' increases human infection and vice versa. Fig. 3.4 shows infectious humans versus time for different values of annual birth of dogs. It can be noted that applying a strategy to control the annual birth of new born puppies is one of the most effective ways to reduce human rabies.

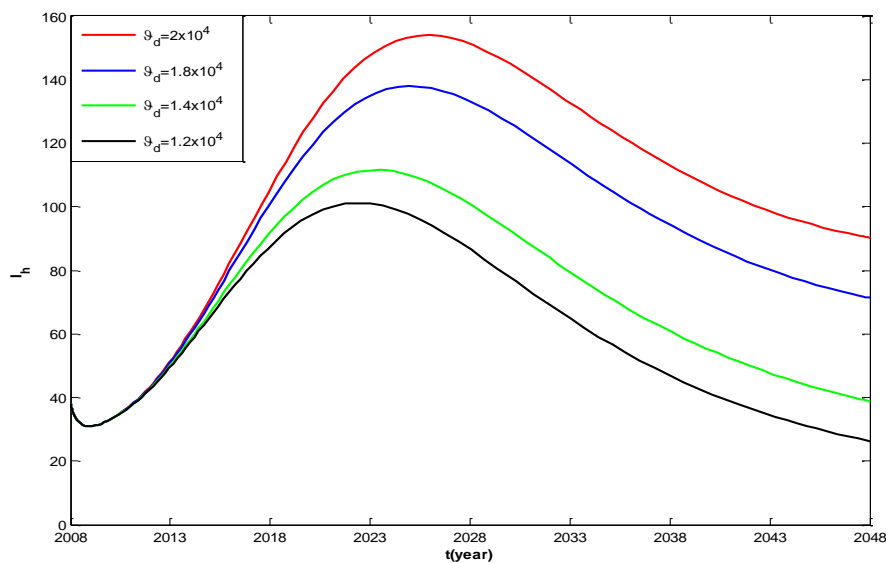

Figure 3.4: The effect of annual birth of dogs g_d for human rabies infection.

During our simulation the annual birth of dogs is estimated to be 20 000. Replacing this value with a lower estimate of 18 000 annual dog birth significantly decreases human infection. This shows that targeting the annual birth of the dog population is very significant to reduce human infection.

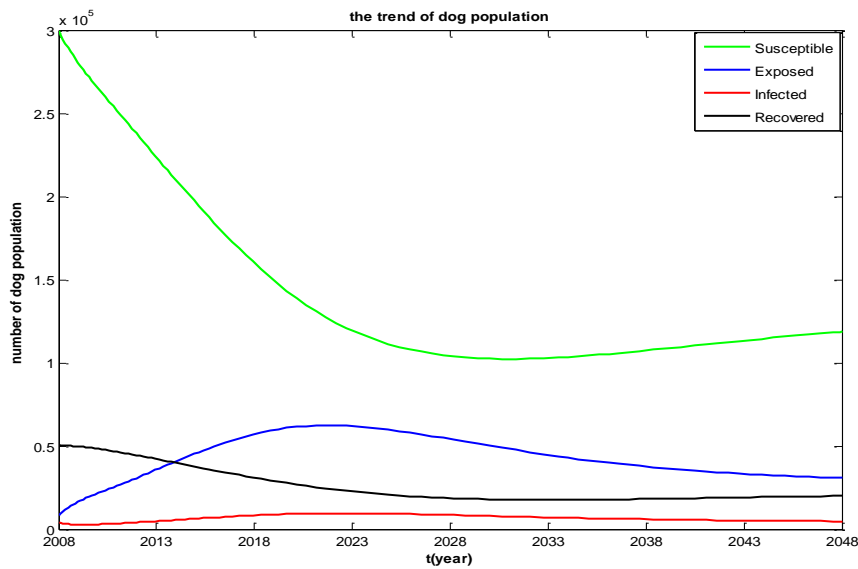

Figure 3.5: Transmission of rabies in dog population in 40 years’ time.

The numerical solution for the dog population in Fig.3.5 shows that based on the current condition of rabies transmission dynamics the disease will not perish. As the susceptible dog population decreases, exposed and infected populations increase. Dog-to-dog transmission is higher than dog-to-human or dog-to-livestock transmission. It is estimated that 70% of the total dog population in Addis Ababa are stray dogs and rabies transmission is more likely in stray dogs than owned dogs. In most cases a stray dog which bites a human will run away. This complicates the quarantine process and the stray dog continues to spread the virus.

Fig 3.6. shows rabies prevalence in the livestock population within and around Addis Ababa. According to the information we got from EPHI there is no rabies vaccine for livestock being used in Ethiopia and little is known about the status of rabies in livestock populations. In our simulation we show how rabies vaccination of livestock has the potential to reduce rabies livestock infection, if this intervention was applied in Ethiopia.

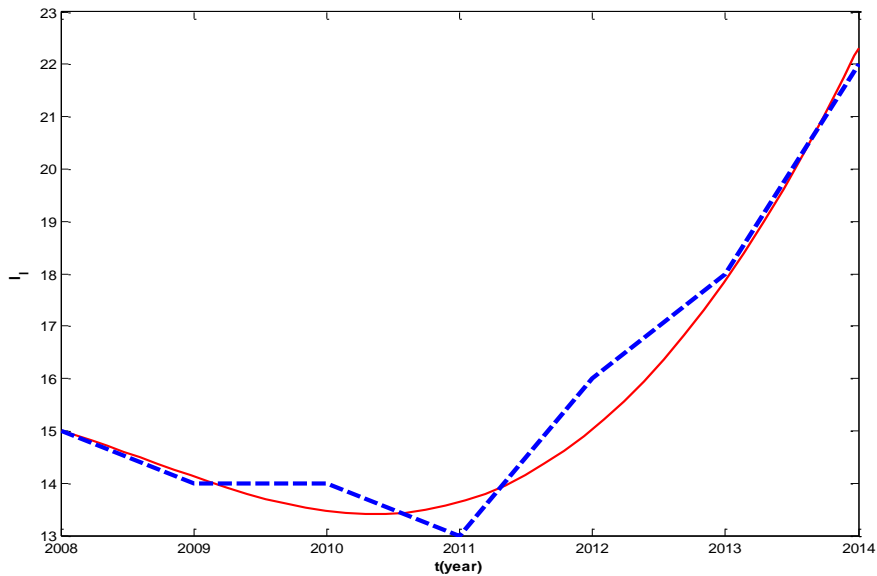

Figure 3.6: Comparison between the reported data and the model simulation of infected livestock population from 2008 to 2014.

The broken curve in Fig.3.6 shows the data reported from EPHI for rabies infected livestock populations. The smooth curve is the simulation of our system. The number of infected livestock decreases from 2008 to 2011 and it increases rapidly from 2011 onwards. The transmission of the rabies virus in livestock populations is underestimated; it is likely there are more livestock infection cases which are not reported to EPHI.

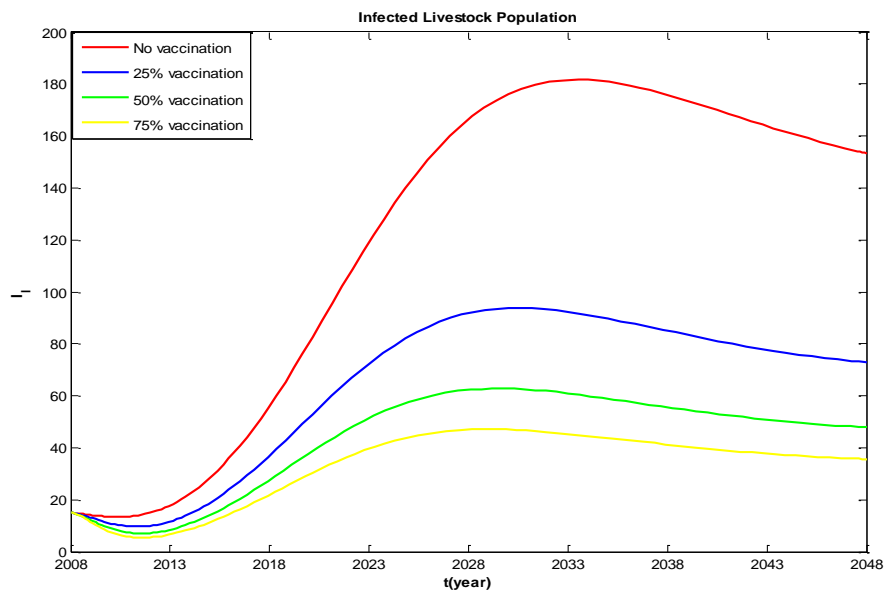

Figure 3.7: The trend of livestock populations with different vaccination coverage in 40 years time.

From Fig.3.7 the rabies virus increases rapidly in the livestock population for the coming seventeen years and will peak in 2033. Aside from control measures which should be taken in dog populations there is a possibility to reduce the disease by applying 25% vaccination coverage in the livestock population, which can cut the number of livestock infections predicted around 2033 by half. Our simulation shows there is no way to eliminate rabies disease by increasing vaccination of livestock alone. With each increase of 25% vaccination coverage the total impact in terms of reductions of rabies infected livestock gets smaller. Even 75% vaccination coverage does not lead to the elimination of the disease. For this reason, we recommend that reducing rabies transmission in the dog population is the best method for controlling the transmission in human and livestock populations.

3.4. Discussion and Conclusion

In this chapter we have done the numerical simulations of the basic reproduction number R_0 , the effective reproduction number R_e and the model system (2.1) with different parameter values. It is found that a combination of interventions in dog populations can greatly reduce rabies infection in human and livestock populations. A 60% vaccination coverage in the dog population reduces the threshold parameter R_e to less than unity, which means rabies will die out from the community. A more aggressive intervention consisting of 60% vaccination coverage in dog populations, 15% culling of stray dogs and reducing the annual crop of newborn puppies by 25% will reduce the number of human and livestock infection by 70% which leads to a faster eradication of the disease from the community. In Fig.3.8 the two upper curves show human and livestock infection cases before interventions in dog populations. After combining interventions in dog populations, the number of infected cases in livestock and humans are greatly reduced as shown by the two lower line curves.

According to the sensitivity analysis that we have performed the annual birth of dogs and dog-to-dog transmission rate are the most positively sensitive parameters. The natural death rate of dogs and disease induced death rate of dogs are the most negatively sensitive parameters. Using numerical simulation of our model, current data predict that rabies transmission within and around Addis Ababa will increase in the coming years. It will peak in 2026, killing more than 150 people before becoming stable. The annual birth of newborn puppies greatly affects rabies infection in humans and livestock. As we decrease the annual birth of puppies by 30%, human and livestock infection also decreases by 30%. Therefore, controlling the annual birth of newborn puppies is one of the best ways to reduce human and livestock rabies infection.

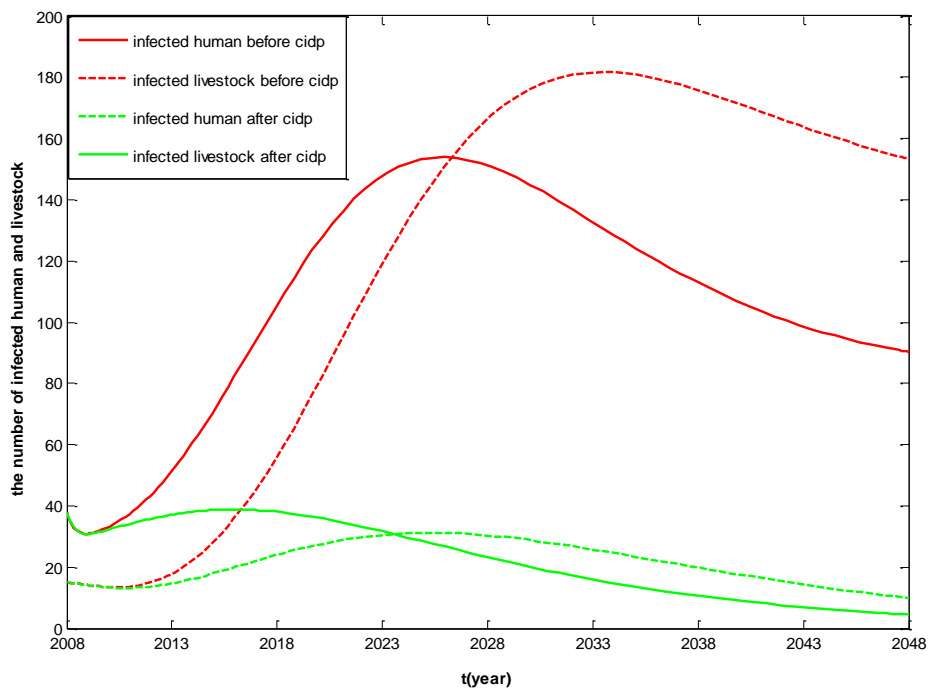

Figure 3. 8 Effects of combining interventions in dog populations (CIDP) on human and livestock rabies infection.

According to our simulations, rabies transmission in livestock populations will increase rapidly in the coming seventeen years. It will peak in 2033, killing more than 180 individuals. We have applied vaccination for different numbers of livestock populations.

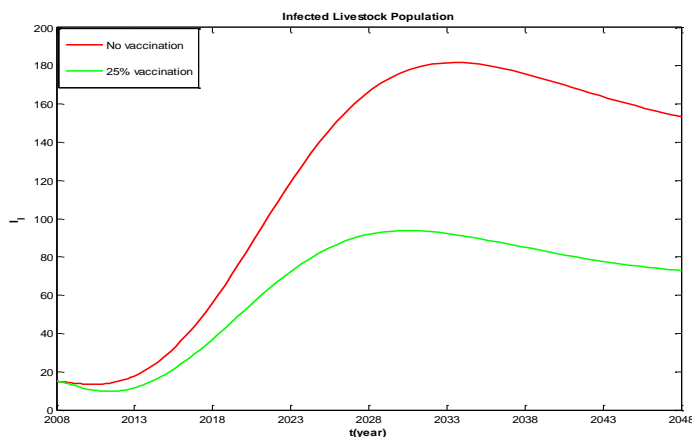

Figure 3.9 Comparison between no vaccination and 25% vaccination for rabies infected livestock.

With 25% vaccination coverage in livestock populations, we can cut the mortality in the coming thirty two years by half. This can be observed from Fig.3.9 by taking the difference between the curves of no vaccination and 25% vaccination. As we increase vaccination

coverage for livestock populations, the number of livestock infections decreases. We strongly recommend that combined interventions in dog populations can be adopted to save many vulnerable individuals within the livestock population.

CHAPTER FOUR

General Discussion, Conclusion and Recommendations

4.1 General Discussion

In this study, we have formulated and analyzed a mathematical model for the dynamics of rabies transmission among dogs and to human and livestock in communities within and around Addis Ababa, Ethiopia. We found the sensitivity of the dynamics of the disease with respect to embedded parameters of the model. The conditions for the existence and stability of endemic and disease free equilibrium points were presented. Numerical solutions of the model were carried out to predict future transmission and to identify sensitive parameters.

Our model comprises of human, dog and livestock populations and is formulated as a system of ordinary differential equations. Since domestic dogs are the main reservoir for rabies, they are found to be the source of infection for both human and livestock populations. As a result it can make sense to target dog populations in the process of combating rabies transmission.

We have computed the basic and effective reproduction numbers using the method of next generation operator. The results entirely depend on the parameters of dog populations. This is because we assume there is no secondary transmission in human and livestock populations due to rare cases. We have simulated the effective reproduction number with different vaccination coverages. According to the results, as we increase the vaccination coverage in dog populations the effective reproduction number decreases. It was likewise noted that if there is no vaccination R_e will be the same as R_0 . We have found that at least 60% of dog population should be immunized to reduce the value of the effective reproduction number to less than unity. Combination of interventions consisting of reducing annual crop of newborn puppies, culling of stray dogs and increasing vaccination coverage in dog population is the best way to combat the spread of rabies.

From already presented literatures both Zhang *et al.*, (2011) and Hou *et al.*, (2012) recommend to avoid culling and substitute this by immunization. Even though culling is not preferable way of controlling rabies, in our study we found that reducing stray dogs by 15% with other combined interventions is very effective. This is because 70% of the total populations are stray dogs which is more than twice of owned dogs. The natural death rate of dogs is one of the most negatively sensitive parameter. In the current situation of Addis Ababa and surrounding areas

it is very difficult to immunize majority of stray dogs. There is one institution only which is dealing with rabies in the entire country.

For estimated values of parameters the basic reproduction number R_0 and the effective reproductive number R_e worked out to be 2 and 1.6 respectively, which indicate that the disease will be endemic in the community. The result we found is very high compared to the result of the basic reproduction number which was found to be $R_0 = 1.2$ in 2009 for African cities. We can see that there is higher rabies burden in and around Addis Ababa.

Sensitivity analysis of R_e is done using the model parameters. This was done to identify the sensitive parameters which drive the dynamics of the disease. The annual crop of newborn puppies \mathcal{G}_d , dog to dog transmission rate β_d , the natural death rate of dogs μ_d and disease related death rate σ_d , are sensitive parameters. It was seen that targeting these parameters in the process of combating rabies will give effective results.

We have simulated system 2.1 for infected human and livestock populations. The simulations significantly support the reported data. It has been observed that human rabies will increase in the coming nine years and peak in 2026. The simulation for the trend of the dog population in 40 years time shows that many dogs will move from susceptible to exposed and infected classes. When the population of infected dogs increases, human and livestock infections also increase. It has been observed in our R_e computation that it is the dog population which is the source of infection for both human and livestock infections. We strongly recommend that interventions target dog populations to control the transmission of rabies.

Another simulation was carried out in which we varied the size of the immunized livestock populations. Simulations show that a significant number of livestock populations are infected with rabies due to dog bites and scratches. The model simulation verifies that there is continued livestock infection within and around Addis Ababa. It will peak in 2033, killing more than 180 individuals. Our simulation shows that at least 25% vaccination coverage in the livestock population is needed to reduce future infections by half.

4.2 Conclusion

Rabies transmission within and around Addis Ababa is underestimated because there is a poor rabies surveillance system. Due to traditional beliefs and limited knowledge about the

transmission and control of rabies, it is estimated that there are a significant number of unreported deaths. The mathematical model that we have developed has given the best results to analyze and predict the transmission of the virus and to combat the disease. It was found that a combination of interventions consisting of the annual crop of newborn puppies, culling of stray dogs and increasing vaccination coverage in dog population is the best way to combat the transmission of rabies.

In the process of combating the transmission of rabies virus it is very important to target parameters including the annual dog births \mathcal{G}_d , dog-to-dog transmission rate β_d , natural death rate of dogs μ_d and disease induced death rate σ_d . These are the most sensitive parameters which control the dynamics of the disease and change the value of R_e . Increasing β_d or \mathcal{G}_d by 10% will increase R_e by 10% and vice versa. Increasing μ_d by 15% will decrease R_e by 18%. On the other hand, decreasing the natural death rate of dogs by 15% will increase R_e by 25%. Thus, targeting the most positively and negatively sensitive parameters in the process of control measures will reduce the transmission of rabies virus within and around Addis Ababa.

The current interventions which are administered against rabies transmission are not ideal compared to the interventions this research recommends. The numerical simulations of our model show that there are increasing number of rabies infections in human, dog and livestock populations. The human rabies infection will peak in 2026 with more than 150 cases. In 2033 more than 180 livestock rabies cases will occur. Intensive interventions should be used in order to control rabies in the dog population. Combining measures of reducing annual crop of newborn puppies and increasing vaccination coverage in dog populations is an effective technique to eradicate rabies from the community. Applying PEP can save exposed humans, but cannot reduce the transmission.

4.3 Recommendations

Based on the results from this study, we strongly recommend the following points.

1. More research should be conducted on the transmission dynamics of rabies. Accurate and proper data handling systems should be developed. Institutions which are dealing with tropical neglected diseases like rabies should be expanded.
2. Educational campaigns like workshops, seminars and trainings should be conducted to create awareness on the transmission of rabies and control measures. There should be media coverage to encourage dog owners to confine their dogs rather than letting them wander free.
3. Government and policy makers should come up with a means to manipulate and bring down the number of stray dogs. A strategy to control annual crop of newborn puppies and to reduce dog-to-dog transmission rate by keeping owned dogs to confined places.
4. Vaccination for dog population should be increased to at least 60%. Government should work to reintroduce the free anti-rabies vaccination program to undertake a mass vaccination exercise which should be followed by the consistent re-vaccination of dogs within and around Addis Ababa.
5. Strategies should focus on the more effective interventions which combine reducing annual crop newborn puppies by 25%, culling stray dogs by 15% and vaccinating at least 60% of dog populations which reduces human and livestock infection by 70% and lead to a fast eradication of the diseases.
6. This study can be extended by applying optimal control theory for a better transmission control. Stochastic models can be applied to consider all random movement of animals or humans.
7. The study was conducted using the context of Addis Ababa and its surrounding areas. It can be done using another region of Ethiopia or another country anywhere in the world.
8. The study can be broadened to incorporate cats, which are the second most important reservoir of rabies after dogs. The dog population can be grouped into owned and stray

REFERENCES

- Addo, K. M. (2012). An SEIR Mathematical Model for Dog Rabies. Case Study: Bongo District, Ghana, *MSc. Dessertation* Kwame Nkrumah University of Science and Technology, p 4-8
- Acha, P. N., & Arambulo, P. V. (1985). Rabies in the tropics—history and current status. In *Rabies in the tropics* (pp. 343-359). Springer Berlin Heidelberg.
- Ali, A., Mamo, H., Nigusie, D., Beshah, F., & Taeme, H. (Eds.) (2012). Rabies Prevention and Control in Ethiopia. In: *the preceedings of Ethiopian Health and Nutrition Research Institute Workshop*, Adama, Ethiopia, 18-19 October, 2012.
- Ali, A., Mengistu, F., Hussen, K., Getahun, G., Deressa, A., Yimer, E., & Tafese, K. (2010). Overview of Rabies in and around Addis Ababa, in Animals Examined in EHNRI Zoonoses Laboratory Between, 2003 and 2009. *Ethiopian Veterinary Journal*, **14**(2), 91-101.
- Chitnis, N., Hyman, J. M., & Cushing, J. M. (2008). Determining important parameters in the spread of malaria through the sensitivity analysis of a mathematical model. *Bulletin of mathematical biology*, **70**(5), 1272-1296.
- Deressa, A., Ali, A., Bayene, M., Selassie, B. N., Yimer, E., & Hussen, K. (2010). The status of rabies in Ethiopia: A retrospective record review. *Ethiopian Journal of Health Development*, **24**(2).
- Hethcote, H. W. (2000). The mathematics of infectious diseases. *SIAM review*, **42**(4), 599-653.
- Hou, Q., Jin, Z., & Ruan, S. (2012). Dynamics of rabies epidemics and the impact of control efforts in Guangdong Province, China. *Journal of theoretical biology*, **300**, 39-47.
- Iggidr, A., Mbang, J., Sallet, G., & Tewa, J.-J. (2007). Multi-compartment models. *Discrete and Continuous Dynamical Systems series S*, **2007**(Special): 506-519.
- Jemberu, W. T., Molla, W., Almaw, G., & Alemu, S. (2013). Incidence of rabies in humans and domestic animals and people's awareness in North Gondar Zone, Ethiopia. *PLoS neglected tropical diseases*, **7**(5), e2216.
- Khan, S. (2012). Rabies molecular virology, diagnosis, prevention and treatment. Available online at <http://www.biomedcentral.com/content/pdf/1743-422X-9-50.pdf>. Retrieved 13 April 2015.

- Knobel, D. L., Cleaveland, S., Coleman, P. G., Fèvre, E. M., Meltzer, M. I., Miranda, M. E. G., & Meslin, F. X. (2005). Re-evaluating the burden of rabies in Africa and Asia. *Bulletin of the World health Organization*, **83**(5): 360-368.
- Lembo, T., Niezgoda, M., Velasco-Villa, A., Cleaveland, S., Ernest, E., & Rupprecht, C. E. (2006). Evaluation of a direct, rapid immunohistochemical test for rabies diagnosis. *Emerging infectious diseases*, **12**(2): 310-313.
- Lloyd, A. L., & Valeika, S. (2007). Network models in epidemiology: an overview. *Complex population dynamics: nonlinear modeling in ecology, epidemiology and genetics*. Available online at http://infoserve.sandia.gov/sand_doc/2008/086044.pdf. Retrieved 13 April 2015
- Mengistu, F., Hussien, K., Ali, A., Getahun, G., & Sifer, D. (2011). Dog bite as a public health concern in Addis Ababa. *Ethiopian Journal of Health Development*, **25**(1): 58-60.
- Nel, L. H. (2013). Discrepancies in data reporting for rabies, Africa. *Emerging infectious diseases*, **19**(4): 529.
- Pankhurst, R. (1970). The history and traditional treatment of rabies in Ethiopia. *Medical history*, **14**(04): 378-389.
- Parks, P. C. (1962). A new proof of the Routh-Hurwitz stability criterion using the second method of Liapunov. *Paper presented at the Mathematical Proceedings of the Cambridge Philosophical Society*.
- Petros A., Yalemtehay M., Gashew G. (2014). Rabies and its Folk Drugs Remedies in Ethiopia: A Review. *European Journal of Biological Sciences* **6** (4): 104-109.
- Reta, T., Teshale, S., Deresa, A., Ali, A., Mengistu, F., Sifer, D., & Freuling, C. (2014). Rabies in animals and humans in and around Addis Ababa, the capital city of Ethiopia: A retrospective and questionnaire based study. *Journal of Veterinary Medicine and Animal Health*, **6**(6): 178-186.
- Sivanandam, S., & Deepa, S. (2007). Linear system design using Routh Column polynomials. *Songklanakarin Journal of Science & Technology*, **29**(6): 1651-1659.
- Van den Driessche, P., & Watmough, J. (2002). Reproduction numbers and sub-threshold endemic equilibria for compartmental models of disease transmission. *Mathematical biosciences*, **180**(1): 29-48.
- WHO. (2013). WHO Expert Consultation on Rabies. Second report. *World Health Organization technical report series*(982), 1.
- Zhang, J., Jin, Z., Sun, G.-Q., Zhou, T., & Ruan, S. (2011). Analysis of rabies in China: transmission dynamics and control. *PLoS One*, **6**(7), e20891.

APPENDICES

MATLAB Codes for Chapter Three

Appendix 1: MATLAB Codes for Fig. 3.1.

Reproduction number for different vaccination coverage, and combination of vaccination, culling, and controlling newborn puppies

```
%R0andRe.m
```

```
%constant values of parameters of reproduction numbers
```

```
%different values of theta, phi and omega.
```

```
hod=1/6; thetad=2*10^4; thetad2=1.5*10^4; omegad=0.5;
mud2=0.09545; mud=0.083; sigmad=1; phid1=0.1; phid2=0.54;
phid4=0.54; phid3=0.81;
betad=0:1*10^-8:1.39*10^-5;
R0=(rhod.*betad*thetad)./(mud*(rhod+mud)*(mud+sigmad));
Re1=(rhod.*betad*thetad*(mud+omegad)./(mud*(mud+phid1+omegad)
*(rhod+mud)*(mud+sigmad));
Re2=(rhod.*betad*thetad*(mud+omegad)./(mud*(mud+phid2+omegad)
*(rhod+mud)*(mud+sigmad));
Re3=(rhod.*betad*thetad*(mud+omegad)./(mud*(mud+phid3+omegad)
*(rhod+mud)*(mud+sigmad));
Re4=(rhod.*betad*thetad2*(mud2+omegad)./(mud2*(mud2+phid4+omegad)
*(rhod+mud2)*(mud2+sigmad));
Y=[R0' Re1' Re2' Re3' Re4']*4;
plot(betad,R0,'r-',betad,Re1,'k-',betad,Re2,'b-',
',betad,Re3,'g',betad,Re4,'y','LineWidth',2)
xlabel('Exposure rate \beta_d')
ylabel('Reproduction number')
legend('R_0','R_{e1}','R_{e2}','R_{e3}','R_{e4}')
title('Variation of Reproduction Number with Exposure rate
\beta_d')
ylim([0 2])
```

Appendix 2: MATLAB Codes for Fig. 3.2

Comparison between reported data and simulation of system (1) for rabies infected human in and around Addis Ababa from 2008 to 2014

```
%Humanrabiesdatafitting.m
clear all
c=['b  ','g  ','r  ','c- ','g  ','b- ','r  ','k- ','r--','m.
','b  ','y  '];
%Paramter used for EEP
thetah=112980; omegah=1; betah=1.29*10^-8; muh=0.016;
rhoh=1/6; phih=0.54; sigmah=1; thetad=20000; omegad=0.5;
betad=1.29*10^-5; mud=0.083; rhod=1/6; phid=0.1; sigmad=1;
thetal=2*10^5; omegal=0; betal=1.18*10^-8; mul=0.05;
rhol=1/6; phil=0; sigmal=1;
Re=(rhod*betad*thetad*(mud+omegad))/(mud*(mud+phid+omegad)*(rhod+mud)*(mud+sigmad));
R0=(rhod*betad*thetad)/(mud*(rhod+mud)*(mud+sigmad));
y0=[5*10^6  100  38  25000  3*10^5  8000  4000  50000  2.5*10^5  90  15
20000];
tspan=[2008 2014];
[t,y]=ode45(@rabiesmodelsystem,tspan,y0,[],thetah,omegah,betah
,muh,rhoh,phih,sigmah,thetad,omegad,betad,mud,rhod,phid,sigmad
,thetal,omegal,betal,mul,rhol,phil,sigmal);
for i=3:3
    plot(t,y(:,i),c(i,:),'Linewidth',2)
    xlabel('t(year)');ylabel('I_{h}')
    hold on
end
time = 2008:1:2014;
I1 = [38 30 33 37 44 52 60];
plot(time,I1,'b--','LineWidth',2)
I1span=[30 35 40 45 50 55 60];
hold on
```

```

%rabiesmodelsystem.m
%function file which has been used for the rest of all m-files
function
f=rabiesmodelsystem(t,y,thetah,omegah,betah,muh,rhoh,phih,sigmah,thetad,omegad,betad,mud,rhod,phid,sigmad,thetal,omegal,betal,mul,rhol,phil,sigmal)
Sh=y(1); Eh=y(2); Ih=y(3); Rh=y(4); Sd=y(5); Ed=y(6); Id=y(7);
Rd=y(8); Sl=y(9); El=y(10); Il=y(11); Rl=y(12);
dSh=thetah+omegah*Rh-betah*Id*Sh-muh*Sh;
dEh=betah*Id*Sh-(rhoh+muh+phih)*Eh;
dIh=rhoh*Eh-(muh+sigmah)*Ih;
dRh=phih*Eh-(omegah+muh)*Rh;
dSd=thetad+omegad*Rd-(mud+phid+betad*Id)*Sd;
dEd=betad*Sd*Id-(rhod+mud)*Ed;
dId=rhod*Ed-(mud+sigmad)*Id;
dRd=phid*Sd-(mud+omegad)*Rd;
dSl=thetal+omegal*Rl-betal*Id*Sl-mul*Sl;
dEl=betal*Id*Sl-(rhol+muh+phil)*El;
dIl=rhol*El-(mul+sigmal)*Il;
dRl=phil*El-(omegal+muh)*Rl;
f=[dSh;dEh;dIh;dRh;dSd;dEd;dId;dRd;dSl;dEl;dIl;dRl];

```

Appendix 3: MATLAB Codes for Fig. 3.3.

The dynamics of rabies infected human for the coming thirty years in and around Addis Ababa.

```

%infectedhuman.m
clear all
c=['b ','g ','r ','c- ','g ','b- ','r ','k- ','r--','m.
','b ','y '];
%Paramter used for EEP
thetah=121980; omeegah=1; betah=1.29*10^-8; muh=0.016;
rhoh=1/6; phih=0.54;sigmah=1; thetad=20000; omegad=0.5;
betad=1.29*10^-5; mud=0.083; rhod=1/6;phid=0.1; sigmad=1;
thetal=2*10^5; omegal=0; betal=1.18*10^-8; mul=0.05;

```

```

rhol=1/6; phil=0; sigmal=1;
Re=(rhod*betad*thetad*(mud+omegad))/(mud*(mud+phid+omegad)*(rhod+mud)*(mud+sigmad));
R0=(rhod*betad*thetad)/(mud*(rhod+mud)*(mud+sigmad));
y0=[5*10^6 100 38 25000 3*10^5 8000 4000 50000 2.5*10^5 90 15 20000];
tspan=[0 40];
[t,y]=ode45(@rabiesmodelsystem,tspan,y0,[],thetah,omegah,betah,muh,rhoh,phih,sigmah,thetad,omegad,betad,mud,rhod,phid,sigmad,thetal,omegal,betal,mul,rhol,phil,sigmal);
for i=3:3
    plot(t,y(:,i),c(i,:), 'Linewidth',2)
    xlabel('t(year)');ylabel('I_{h}')
set(gca,'XTickLabel',[2008 2013 2018 2023 2028 2033 2038 2043 2048] )
set(gca,'YLim',[0 160])
    hold on
end

```

Appendix 4: MATLAB codes for Fig. 3.4.

The effect of annual birth of dog population to human rabies infection.

```

%newbornpuppies
clear all
%changing the color of infected human for each thetad
c=['b ' ;'g ' ;'r ' ;'c- ' ;'g ' ;'b- ' ;'r ' ;'k- ' ;'r--' ;'m. ' ;'b ' ;'y ' ];
%Paramter used for EEP
thetah=121980; omegah=1; betah=1.29*10^-8; muh=0.016;
rhoh=1/6; phih=0.54;sigmah=1;
%change the value of thetad(annual crop of newborn puppies)
for each simulation of human infection
thetad=20000;
% thetad=18000;
% thetad=14000;

```

```

% thetad=12000;
omegad=0.5; betad=1.29*10^-5; mud=0.083; rhod=1/6; phid=0.1;
sigmad=1; thetal=2*10^5; omegal=0; betal=1.18*10^-8;
mul=0.05; rhol=1/6; phil=0; sigmal=1;
Re=(rhod*betad*thetad*(mud+omegad))/(mud*(mud+phid+omegad)*(rhod+mud)*(mud+sigmad));
R0=(rhod*betad*thetad)/(mud*(rhod+mud)*(mud+sigmad));
y0=[5*10^6 100 38 25000 3*10^5 8000 4000 50000 2.5*10^5 90 15 20000];
tspan=[0 40];
[t,y]=ode45(@rabiesmodelsystem,tspan,y0,[],thetah,omegah,betah,muh,rhoh,phih,sigmah,thetad,omegad,betad,mud,rhod,phid,sigmad,thetal,omegal,betal,mul,rhol,phil,sigmal);
for i=3:3
    plot(t,y(:,i),c(i,:), 'Linewidth',2)
legend('\vartheta_d=2x10^4', '\vartheta_d=1.8x10^4', '\vartheta_d=1.4x10^4', '\vartheta_d=1.2x10^4')
xlabel('t (year)'); ylabel('I_h')
set(gca, 'XTickLabel', [2008 2013 2018 2023 2028 2033 2038 2043 2048])
    hold on
end

```

Appendix 5: MATLAB codes for Fig. 3.5.

Transmission of rabies in dog population in 40 years' time

```

%dogpopulation.m
clear all
c=['b ' ; 'g ' ; 'r ' ; 'c- ' ; 'g ' ; 'b- ' ; 'r ' ; 'k- ' ; 'r--' ; 'm. ' ; 'b ' ; 'y ' ];
%Paramter used for EEP
thetah=121980; omegah=1; betah=1.29*10^-8; muh=0.016;
rhoh=1/6; phih=0.54; sigmah=1; thetad=20000; omegad=0.5;
betad=1.29*10^-5; mud=0.083; rhod=1/6; phid=0.1; sigmad=1;
thetal=2*10^5; omegal=0; betal=1.18*10^-8; mul=0.05;

```

```

rhol=1/6; phil=0;sigmal=1;
Re=(rhod*betad*thetad*(mud+omegad))/(mud*(mud+phid+omegad)*(rhod+mud)*(mud+sigmad));
R0=(rhod*betad*thetad)/(mud*(rhod+mud)*(mud+sigmad));
y0=[5*10^6 100 38 25000 3*10^5 8000 4000 50000 2.5*10^5 90 15 20000];
tspan=[0 40];
[t,y]=ode45(@rabiesmodelsystem,tspan,y0,[],thetah,omegah,betah,muh,rhoh,phih,sigmah,thetad,omegad,betad,mud,rhod,phid,sigmad,thetal,omegal,betal,mul,rhol,phil,sigmal);
for i=5:8
    plot(t,y(:,i),c(i,:), 'Linewidth',2)
title('Trend of dog population')
ylabel('Number of dog population')
legend('Susceptible','Exposed','Infected','Recovered')
xlabel('t(year)');
set(gca,'XTickLabel',[2008 2013 2018 2023 2028 2033 2038 2043 2048] )
    hold on
end

```

Appendix 6: MATLAB codes for Fig. 3.6.

Comparison between the reported data and the model simulation for infected livestock population from 2008 to 2014.

```

clear all
c=['b ','g ','r ','c- ','g ','b- ','r ','k- ','r-- ','m. ','r ','y '];
%Paramter used for EEP
thetah=121980; omegah=1; betah=1.29*10^-8; muh=0.016;
rhoh=1/6; phih=0.54;
sigmah=1; thetad=20000; omegad=0.5; betad=1.29*10^-5;
mud=0.083; rhod=1/6; phid=0.1; sigmad=1; thetal=2*10^5;
omegal=0; betal=1.18*10^-8; mul=0.05; rhol=1/6; phil=0;
sigmal=1;

```

```

Re=(rhod*betad*thetad*(mud+omegad))/(mud*(mud+phid+omegad)*(rhod+mud)*(mud+sigmad));
R0=(rhod*betad*thetad)/(mud*(rhod+mud)*(mud+sigmad));
y0=[5*10^6 100 38 25000 3*10^5 8000 4000 50000 2.5*10^5 90 15 20000];
tspan=[2008 2014];
[t,y]=ode45(@rabiesmodelsystem,tspan,y0,[],thetah,omegah,betah,muh,rhoh,phih,sigmah,thetad,omegad,betad,mud,rhod,phid,sigmad,thetal,omegal,betal,mul,rhol,phil,sigmal);
for i=11:11
    plot(t,y(:,i),c(i,:), 'Linewidth',2)
    xlabel('t(year)');
    ylabel('I_{1}')
    hold on
end
time = 2008:1:2014;
I1 = [15 14 14 13 16 18 22];
plot(time,I1,'b--','LineWidth',2)
I1span = [30 35 40 45 50 55 60];
hold on

```

Appendix 7: MATLAB codes for Fig. 3.7.

The trend of livestock population with different vaccination coverage in 40 years' time

```

%livestockvaccination
clear all
c=['b ','g ','r ','c- ','g ','b- ','r ','k- ','r-- ','m. ','b ','y '];
%Paramter used for EEP
thetah=121980; omegah=1; betah=1.29*10^-8; muh=0.016;
rhoh=1/6; phih=0.54; sigmah=1; thetad=20000; omegad=0.5;
betad=1.29*10^-5; mud=0.083; rhod=1/6; phid=0.1; sigmad=1;
thetal=2*10^5; omegal=0; betal=1.18*10^-8; mul=0.05;
rhol=1/6;
phil=0;

```

```

% phil=0.225;
% phil=0.45;
% phil=0.675;
signal=1;
Re=(rhod*betad*thetad*(mud+omegad))/(mud*(mud+phid+omegad)*(rhod+mud)*(mud+sigmad));
R0=(rhod*betad*thetad)/(mud*(rhod+mud)*(mud+sigmad));
y0=[5*10^6 100 38 25000 3*10^5 8000 4000 50000 2.5*10^5 90 15 20000];
tspan=[0 40];
[t,y]=ode45(@rabiesmodelsystem,tspan,y0,[],thetah,omegah,betah,muh,rhoh,phih,sigmah,thetad,omegad,betad,mud,rhod,phid,sigmad,thetal,omegal,betal,mul,rhol,phil,signal);
for i=11:11
    plot(t,y(:,i),c(i,:), 'Linewidth',2)
title('Infected Livestock Population')
legend('No vaccination','25% vaccination','50% vaccination','75% vaccination')
xlabel('t(year)');
ylabel('I_{1}')
set(gca,'XTickLabel',[2008 2013 2018 2023 2028 2033 2038 2043 2048])
    hold on
end

```

Appendix 8: MATLAB codes for Fig. 3.8.

The effect of combination of interventions in dog populations on human and livestock rabies infection.

```

%infectedhuman.m
clear all
c=['b ','g ','r ','c- ','g ','b- ','r ','k- ','r-- ','m. ','g-- ','y '];
%Paramter used for EEP

```



```

thetah=121980; omegah=1; betah=1.29*10^-8; muh=0.016;
rhoh=1/6; phih=0.54; sigmah=1;
% thetad=20000;
thetad=15000; omegad=0.5;
betad=1.29*10^-5;
% mud=0.083;
mud=0.09545;
rhod=1/6;
% phid=0.1;
phid=0.54;
sigmad=1; thetal=2*10^5; omegal=0; betal=1.18*10^-8;
mul=0.05;
rhol=1/6; phil=0; sigmal=1;
Re=(rhod*betad*thetad*(mud+omegad))/(mud*(mud+phid+omegad)*(rhod+mud)*(mud+sigmad));
R0=(rhod*betad*thetad)/(mud*(rhod+mud)*(mud+sigmad));
y0=[5*10^6 100 38 25000 3*10^5 8000 4000 50000 2.5*10^5 90 15 20000];
tspan=[0 40];
[t,y]=ode45(@rabiesmodelsystem,tspan,y0,[],thetah,omegah,betah,muh,rhoh,phih,sigmah,thetad,omegad,betad,mud,rhod,phid,sigmad,thetal,omegal,betal,mul,rhol,phil,sigmal);
for i=11:11
    plot(t,y(:,i),c(i,:), 'Linewidth',2)
    legend('infected human before cid','infected livestock before cid','infected human after cid','infected livestock after cid')
    xlabel('t(year)');ylabel('the number of infected human and livestock')
set(gca,'XTickLabel',[2008 2013 2018 2023 2028 2033 2038 2043 2048] )
    hold on
end

```

Appendix 9: MATLAB codes for Fig. 3.9

Comparison between no vaccination and 25% vaccination for rabies infected livestock.

```
%livestockvaccination
clear all
c=['b ' ;'g ' ;'r ' ;'c- ' ;'g ' ;'b- ' ;'r ' ;'k- ' ;'r--' ;'m.
  ' ;'g ' ;'y ' ];
%Paramter used for EEP
thetah=121980; omegah=1; betah=1.29*10^-8; muh=0.016;
rhoh=1/6;
phih=0.54; sigmah=1; thetad=20000; omegad=0.5; betad=1.29*10^-
5; mud=0.083; rhod=1/6; phid=0.1; sigmad=1; thetal=2*10^5;
omegal=0; betal=1.18*10^-8; mul=0.05; rhol=1/6;
phil=0;
% phil=0.225;
signal=1;
Re=(rhod*betad*thetad*(mud+omegad))/(mud*(mud+phid+omegad)*(rh
od+mud)*(mud+sigmad));
R0=(rhod*betad*thetad)/(mud*(rhod+mud)*(mud+sigmad));
y0=[5*10^6 100 38 25000 3*10^5 8000 4000 50000 2.5*10^5 90 15
20000];
tspan=[0 40];
[t,y]=ode45(@rabiesmodelsystem,tspan,y0,[],thetah,omegah,betah
,muh,rhoh,phih,sigmah,thetad,omegad,betad,mud,rhod,phid,sigmad
,thetal,omegal,betal,mul,rhol,phil,signal);
for i=11:11
    plot(t,y(:,i),c(i,:), 'Linewidth',2)
title('Infected Livestock Population')
legend('No vaccination','25% vaccination','50%
vaccination','75% vaccination')
xlabel('t(year)');
ylabel('I_{1}')
    hold on
end
```