

2021-07

Modelling the spread and control of prosopis juliflora plants

Simon, Joel

NM-AIST

<https://doi.org/10.58694/20.500.12479/1351>

Provided with love from The Nelson Mandela African Institution of Science and Technology

**MODELLING THE SPREAD AND CONTROL OF *PROSOPIS JULIFLORA*
PLANTS**

Joel Simon

**A Dissertation Submitted in Partial Fulfillment of the Requirements for the Degree of
Master's in Mathematical and Computer Sciences and Engineering of the Nelson
Mandela African Institution of Science and Technology**

Arusha, Tanzania

July, 2021

ABSTRACT

The *Prosopis juliflora* plant is a thorny leguminous shrub or small tree, a kind of mesquite in a family of Fabacea. It is extremely aggressive and invasive. The spreading agents include livestock dispersal and seeds in their droppings, human activity by vegetation restoration, firewood and charcoal and soil erosion control. In this study a deterministic model examines the dynamics of *Prosopis juliflora* plant by adopting a similar approach of a dynamical system as used in epidemiological modeling. The local and global stability analyses of the equilibrium points of the model were conducted by using next generation matrix for the computation of basic reproduction number R_0 and Lypunov function. The study showed that the *Prosopis juliflora* plant free equilibrium of the model is both locally and globally asymptotically stable if and only if the number of secondary infections is less than unity, that is if $R_0 < 1$. Furthermore, the study shows that there exists *Prosopis juliflora* endemic equilibrium for the spread of the plant when $R_0 > 1$. The numerical simulation was implemented in MATLAB ODE 45 algorithm for solving linear ordinary differential equations. The study showed that the plant spread with an increase of animals that ingested it. Based on the study, recommended is the application of the model on the endemic area to improve the existing situation through: Enlightening and involving policymakers, environmentalists, stakeholders and community groups in the preservation framework on the spread and control strategy of the *Prosopis juliflora* invasion.

Keywords: *Prosopis juliflora* plant, Mathematical model, Equilibria, Stability and Numerical simulation

DECLARATION

I, **Joel Simon**, do hereby declare to the Senate of Nelson Mandela African Institution of Science and Technology that this dissertation is my own original work and that it has neither been submitted nor presented for a similar award in any other institution.

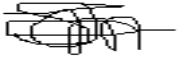

Joel Simon
(Candidate)

02th November, 2020

Date

The above declaration is confirmed



2020
Dr. Silas Mirau
(Supervisor 1)

09th November,

Date

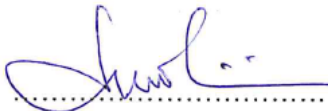

Prof. Livingstone S Luboobi
(Supervisor 2)

10 November 2020

Date

COPYRIGHT

This dissertation is copyright material protected under the Berne Convention, the Copyright Act of 1999 and other international and national enactments, in that behalf, on intellectual property. It must not be reproduced by any means, in full or in part, except for short extracts in fair dealing; for researcher private study, critical scholarly review or discourse with an acknowledgement, without a written permission of the Deputy Vice Chancellor for Academic, Research and Innovation, on behalf of both the author and the Nelson Mandela African Institution of Science and Technology.

CERTIFICATION

The undersigned certify that they have read and hereby recommend for acceptance by the Nelson Mandela African Institution of Science and Technology the dissertation entitled: Modeling The Spread and Control Of *Prosopis Juliflora* Plants, in fulfillment of the requirements for the degree of Master's in Mathematical and Computer Sciences and Engineering of the Nelson Mandela African Institution of Science and Technology.



Dr. Silas Mirau
(Supervisor 1)

09th November, 2020

Date

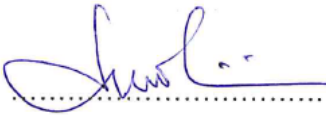

Prof. Livingstone S Luboobi
(Supervisor 2)

10 November 2020

Date

ACKNOWLEDGEMENT

I give thanks to Almighty God for protecting and granting me grace throughout working and completing this work. I appreciate the advice and guidance provided to me by my supervisors Prof. Livingstone S. Luboobi and Dr. Silas Mirau and for their constructive criticisms. Let me take this opportunity to express my gratitude to Dr. Shubi Kaijage (Dean of CoCSE), Dr. Kisangiri Michael, Dr. Anael Sam, Dr. Dina Machuve, Dr. Musa Dida, Dr. Edith Luhanga, Dr. Silas Mirau and all members of the School of CoCSE for their invaluable contributions and support through their advice and encouragement to the successful accomplishment of this work. Special thanks be extended to the Nelson Mandela African Institution of Science and Technology (NM-AIST) who granted me an opportunity to be the part of their community. I sincerely appreciate the higher learning students loans Board (HESLB) for their financial support in the absence of which I could not have managed. I also acknowledge with thanks my former employer the District Executive Director (DED) Kyerwa for allowing me to pursue my studies. My sincere appreciation also goes to Dr. Mark Kimathi, and Mr. Nkuba Nyerere and all of my classmates for their contribution and support in this work.

DEDICATION

I dedicate this work to my beloved wife Ziyuni Hamza for her advice, encouragement, material support, prayers and above all her unconditional love, my sons Simon Joel Simon and Ibrahim Joel Simon, my beloved daughter Samiath Joel Simon and all my family members. You were my strengths.

TABLE OF CONTENTS

ABSTRACT	i
DECLARATION.....	ii
COPYRIGHT	ii
CERTIFICATION	iv
ACKNOWLEDGEMENT.....	v
DEDICATION	vi
TABLE OF CONTENTS	vii
LIST OF TABLES	ix
LIST OF FIGURES	x
LIST OF APPENDICES	xi
LIST OF ABBREVIATIONS AND SYMBOLS.....	xii
CHAPTER ONE.....	1
INTRODUCTION	1
1.1 Background of the Problem.....	1
1.2 Statement of the Problem	2
1.3 Rationale of the Study	3
1.4 Research Objectives.....	3
1.4.1 General Objective.....	3
1.4.2 Specific Objectives.....	3
1.5 Research Questions.....	3
1.6 Significance of the Study.....	4
1.7 Delineation of the Study	4
CHAPTER TWO.....	5
LITERATURE REVIEW	5
2.1 General Overview.....	5
2.2 <i>Prosopis Juliflora</i> Mathematical Model.....	6
CHAPTER THREE	8
MATERIALS AND METHODS	8
3.1 Design and Methods	8
3.1.1 Model Formulation.....	8
3.1.2 Model Assumptions	9
3.1.3 Flow Diagram Chart.....	10
3.2 Basic Properties of the Model	11
3.2.1 Positivity of solutions	11

3.3	Invariant Region	13
3.4	Model Analysis.....	16
3.4.1	Existence of <i>Prosopis</i> Free Equilibrium (PFE) Point	16
3.4.2	Local stability of <i>Prosopis juliflora</i> Free Equilibrium point (PFE).....	17
3.4.3	The <i>Prosopis</i> Endemic Equilibrium Point (PEE)	18
3.4.4	Reproduction Number R_0 of <i>Prosopis juliflora</i> Dynamics	19
3.4.5	Global Stability of <i>Prosopis juliflora</i> Free Equilibrium Point (PFE)	21
3.5	Sensitivity Analysis of basic Reproduction Number R_0	23
CHAPTER FOUR		25
RESULTS AND DISCUSSION.....		25
4.1	Results and Discussion	25
4.1.1	Numerical Simulation	25
4.1.2	Determination impact of each of the parameters on the control of the spread of <i>Prosopis juliflora</i> plant.....	29
CHAPTER FIVE		30
CONCLUSION AND RECOMMENDATIONS		30
5.1	Conclusion	30
5.2	Recommendations	30
REFERENCES		32
RESEARCH OUTPUTS		44

LIST OF TABLES

Table 1: Five variables for both land and animal populations.....	9
Table 2: Parameters and their descriptions.....	10
Table 3: Sensitivity indices for R_0	24

LIST OF FIGURES

Figure 1: Current and potential distribution area of <i>Prosopis juliflora</i> plant in Tanzania (Kilawe <i>et al.</i> , 2017).....	1
Figure 2: The flow diagram for the spread of <i>Prosopis juliflora</i> plant on piece of land by animals that ingest the plant seeds	10
Figure 3: Dynamics of <i>Prosopis juliflora</i> Plants on Acres of Land.....	25
Figure 4: (a) Effects of variation of Λ_2 on Land (b) Effects of variation β_2 with infected Land.....	26
Figure 5: (a) Effects of Infested Land and Susceptible land (b) Ingested Animals and Susceptible land.....	27
Figure 6: Variation of Ingested Animals on Acres of Land.....	28
Figure 7: (a)The spread of <i>Prosopis Juliflora</i> plants (b)The spread of <i>Prosopis Juliflora</i> plants before control in 1.5 Months after control in 1.5 Months	29
Figure 8: The spread of <i>Prosopis Juliflora</i> plants after control in 10 Months.....	29

LIST OF APPENDICES

Appendix 1: Matlab Codes for Figure 3.....	35
Appendix 2: Matlab Codes for Figure 4 a.....	36
Appendix 3: Matlab Codes for Figure 4 b.....	37
Appendix 4: Matlab Codes for Figure 5 a.....	38
Appendix 5: Matlab Codes for Figure 5 b.....	39
Appendix 6: Matlab Codes for Figure 6.....	40
Appendix 7: Matlab Codes for Figure 7 a.....	41
Appendix 8: Matlab Codes for Figure 7 b.....	42
Appendix 9: Matlab Codes for Figure 8.....	43

LIST OF ABBREVIATIONS AND SYMBOLS

ACRONYM DEFINITION

COCSE Communication and Computational Science and Engineering

PFE *Prosopis* Free Equilibrium

PEE *Prosopis* Endemic Equilibrium

ODE Ordinary Differential Equation

NM-AIST The Nelson Mandela Institution of Science and Technology

R_0 Basic Reproduction number

S_L Susceptible land

I_L Invaded land

R_L Reclaimed land

HESLB Higher Education Students' Loans Board

S_A Susceptible animals

I_A Infestation animals

DED District Executive Director

CABI Centre for Agriculture and Bioscience International

CHAPTER ONE

INTRODUCTION

1.1 Background of the Problem

The *Prosopis juliflora* is a thorny leguminous shrub or small tree a kind of mesquite in a family of Fabaceae. It is extremely aggressive and invasive. From its origins in the South Americas it made its way into East Africa mainly Northern Uganda and Kenya and quickly proliferated to Tanzania in the 1980s particularly the northern enclave of Mwanga in the Kilimanjaro region. The plant is widely used locally for firewood and in the charcoal production. It is also quite effective as a wind shelter and its quick proliferation and survival in dry conditions renders it a choice agent for combating desertification and the restoration of vegetation in arid and semi-arid areas.

The leading agents for the spread of the plant include livestock movements as they cross from one place to another by way of dispersal and their ready to germinate seeds in their droppings, human activity due to vegetation restoration, firewood, and charcoal as well as soil erosion control (Kilawe *et al.*, 2017). The plant can also be spread by any other means that enables water to facilitate the germination of the seeds. The following is the map showing the invaded area in Tanzania (Kilawe *et al.*, 2017).

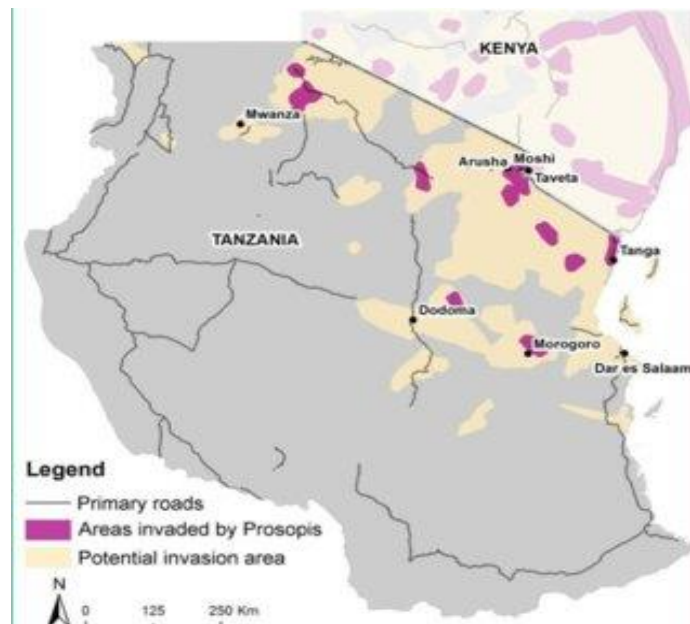

Figure 1: Current and potential distribution area of *Prosopis juliflora* plant in Tanzania (Kilawe *et al.*, 2017)

As regards to the plant's impact on the environment, its rapid invasion displaces the indigenous vegetation thus interfering with the appropriate utilization of resources. It is important to

appreciate the adverse effect the plant has on the disruption of the natural ecological balance especially on indigenous species, its rapid expansion invading open spaces and paths prevents penetration access and productive activities (Meroni *et al.*, 2017). In East Africa, the *Prosopis juliflora* plant is a disaster on biodiversity and measures to eradicate its presence are inevitable. Currently the Centre for Agriculture and Bioscience International (CABI) has embarked on measures to eradicate the plant from Tanzania, Kenya, and Ethiopia. However, in areas already invaded by the plant adverse effects are noted on the land quality, livestock activities, agricultural activities, and water availability (Obiri, 2011). Efforts Are in place towards this goal and countries such as Kenya, Ethiopia, Sudan, South Sudan, and South Africa have published National Management Strategies against this invasive plant (Eckert *et al.*, 2020).

The serious adverse effects posed by the *Prosopis juliflora* plant in Tanzania calls for concerted measures of its containment and control because of its negative impact on livestock and indigenous species. This includes illness of livestock, replacement of native plants, and accelerating invasion to another unexposed land (Obiri, 2011). However, the control of invasiveness of the plant should go hand in hand with the creation of awareness of its negative impact to the stakeholders and the general public.

1.2 Statement of the Problem

The plant grows and survives in any place, including arid, semi-arid, and non-arid conditions, and it may result in the disaster of native species replacement. The *Prosopis juliflora* plant can be spread on land by livestock movement through their droppings mainly dung. The high germination nature of the seed that has been ingested by livestock spreads rapidly through dung. This mechanism of the seed dispersal and its extensive-range ecological adaptability are the main drivers for the high invasion rate of the expansion of the *Prosopis juliflora* plant affecting human health, suppressing indigenous plants and decreasing livestock productivity.

So far few studies among others have conducted studies on a plant using statistical and biological approach and none of these studies conducted mathematical model on epidemiological approach (Haregeweyn *et al.*, 2013; Mazimbuko, 2012; Tilahun & Asfaw, 2012). This study aims at formulating a mathematical model which describes the spread and control measures of *Prosopis juliflora* plant due to animal movement on acres of land through application of epidemiological approach.

1.3 Rationale of the Study

The study aims at providing a solution for the precarious situation caused by the *Prosopis juliflora* plant and other invasive species. Furthermore, the findings of the study paves a way forward to contain its invasiveness which negatively affect livestock, environmental, agricultural and fishing activities. Concerted efforts should be put in place toward off animals from invaded areas to curb ingesting the *Prosopis juliflora* plant pods and seeds that facilitate its spread in Tanzania and African countries in general.

1.4 Research Objectives

1.4.1 General Objective

The general objective of the research is to develop and analyze a mathematical model for the dynamics and spread control of the *Prosopis juliflora* plants.

1.4.2 Specific Objectives

- (i) To formulate a mathematical model describing the spread of *Prosopis juliflora* due to livestock movement on land.
- (ii) To derive equilibrium states of *Prosopis* plant and establish conditions for their stability.
- (iii) To compute basic reproduction number and find which parameter are sensitive to the spread of *Prosopis juliflora* plant.

1.5 Research Questions

- (i) How can a Mathematical Model for the dynamics and spread control of the *Prosopis juliflora* plant be formulated?
- (ii) To what extent does livestock contribute in spread of the *Prosopis juliflora* plant?
- (iii) How will the sensitivity analysis be obtained?
- (iv) What is the optimal method of controlling the spread of the *Prosopis juliflora* plant that spares the needed vegetation without invading the farmland?

1.6 Significance of the Study

The findings from the study will benefit society, government and other stakeholders on the plant invasion understanding and control measures. Through this study it justifies that there is a need of having best strategy to manage and control the spread and control of *Prosopis juliflora* plants to policy makers, society and government as whole by implementing control measures suggested by this study. Through application of study control measures towards the invasion farming, pastoralism and fishing activities will be conducted without any interference.

1.7 Delineation of the Study

In fact, mathematical modeling of *Prosopis juliflora* plants considered livestock as the main agency of spreading the plant and concentrated in some places where the invasion is very high due to the limitation of time.

CHAPTER TWO

LITERATURE REVIEW

2.1 General Overview

The first point of entry of the *Prosopis juliflora* plant from the Americas in the late 1800 into the African continent was South Africa where it was widely distributed and planted up to 1960 to provide fodder and shade during a time of severe drought (Mazibuko, 2012). It also served as a wind shelter, prevention of soil erosion and restoration of vegetation as well as providing firewood and charcoal for domestic consumption.

It was later that the plant's adverse effects became apparent outweighing the advantages that had been envisaged. It negatively impacted the environment especially causing soil fertility decline which degrades the quality of land for livestock grazing and farming. However, the plant has proved very difficult to control and eradicate due to the rapid expansion of the invaded areas. Furthermore the interventions and management of *Prosopis juliflora* including removal, restoration on the invaded land, rehabilitation and use of cleared area and prevention of further spread lead into national and regional research extension programs towards the plant (Assefa, 2017). The negative impact of the plant species in a biological and human context, ecological, social and environmental aspects is clearly revealed (Shackleton *et al.*, 2017). The other negative effects of the *Prosopis juliflora* plant are the death of live stocks by poisoning and destroying the indigenous flora. It has already invaded 500 000 and 700 000 hectares in Kenya and Ethiopia respectively and this rate is alarming.

It also makes the soil loose and as such unable to retain water, moreover foliage for feeding wildlife animals is highly curtailed resulting into starvation and death of animals. It is revealed that the invaded area was at a rate of 3.48 kilometers square per annum for a newly invaded area as a result by 2020, thirty point eight one percent (30.81%) of the study area will be covered by the plant as the result of displacement of native species and decrease of livestock productivity (Haregeweyn *et al.*, 2013). However, in Ethiopia, the *Prosopis juliflora* grows so fast to make thick forests such that land can no longer be accessed for other economic activities. Also, the existence of this plant had been reported not only to have disrupted the natural ecological balance and loss of agricultural land but also to sustain physical injuries to those working on the invaded land. The government of Ethiopia, through her ministry of agriculture, somehow tries to recover the agricultural land after having managed to remove the *Prosopis juliflora* plant on the invaded land and explained much on the negative impact of the plant (Obiri, 2011; Mudavanhu *et al.*, 2017). Several countries

including Kenya, Sudan, Eritrea, Malawi, and Pakistan outlined the serious negative impact of *Prosopis juliflora* invasion to their communities.

2.2 *Prosopis Juliflora* Mathematical Model

Tilahun and Asfaw (2012) developed a mathematical model on estimating the rate of *Prosopis juliflora* plant expansion in the Middle Awash area of Afar Region in Ethiopia by using the least square method and secondary data for twenty years. It showed that the spread of the plant in the Afar region of Ethiopia was at a rate of 50 000 hectares per year, and in the model they had developed, proposed that after 15 years from the date of research, *Prosopis juliflora* could be contained within 200 000 hectares, which is dangerous and environmentally alarming. However, there are some studies that developed dynamical epidemiological mathematical models using techniques of sensitivity analysis, numerical simulation to formulate the model by means of compartmental diagram, and differential equations (Aloyce & Kuznetsov, 2017).

Studies, pointed out that invasive species always harm the existence of indigenous species a model was developed to measure the biological risks of plant species through identifying potential invaders compared to manual conducted risks assessment (Peiris *et al.*, 2013), developed Mechanistic models for the spatial spread of species under climate change. The study used a reaction-diffusion equation in describing a change in the density of population over a climate to predict the speed of spatial spread of locally introduced species in an unbounded homogeneous landscape. The mathematical model provides an analytical measure that can estimate past and present; and predict the future species responses to the changing climate.

Modes of an invasive species to identify the unrecognized evolutionary process that involves an interaction between life history and dispersal evolution during the expansion, distance spread under various evolutionary stages has been developed. Alex *et al.* (2013) and Edward (2014) developed deterministic epidemiological model. They used reproductive number in the determination of model equilibrium and stability and sensitivity analysis as well as they performed numerical simulation. In our model we will use a similar epidemiological approach in determining the model equilibria. Zhonghua and Yaohong (2014) developed an epidemiological dynamical stability and sensitivity analysis. They used reproductive number, Jacobian matrix and eventually performed numerical simulation. In this study the same approach in implementing the spread of *Prosopis juliflora* plant model was adopted; the only difference being our model is an ecological model.

Tilahun and Asfaw (2012) developed a mathematical model on the expansion of the *Prosopis juliflora* plant in the Afar region in Ethiopia they used the least square method and optimization on plant economic benefits. It was also proved that through using resistant varieties of Alfalfa can increase yield up to eighty three percent (83%) and slow down invasion speeds of nematodes species (Negara, 2015). Aloyce and Kuznetsov (2017) developed an epi-ecological dynamical model on maize population and performed sensitivity analysis, numerical simulation and they managed to formulate the model by means of compartmental diagram and differential equations.

Through observing the impact of *Prosopis juliflora* plant and all ways in which different scholars acted upon the challenge, presented an opportunity to model the *Prosopis juliflora* plant as a dynamical system. Developing a mathematical model on the spread and control of the *Prosopis Julifrola* plant, used will be the methods applied in the epidemiological model to apply ecological mathematical model to explain the spread and control of the *Prosopis julifrola* plant. Moreover, differential equations to study the dynamics, stability, and sensitivity analysis used to reflect the real situation of the spread of the plant and its control through varying the parameters.

Therefore, through the development of a mathematical dynamic system model for controlling and eradicating the spread of the *Prosopis julifrola* plant, agricultural activities will be enhanced, indigenous species will be restored and livestock activities will be improved.

CHAPTER THREE

MATERIALS AND METHODS

3.1 Design and Methods

The study involves model formulation in the first phase and model analysis in the second phase. However, the assessment of various parameters on the control and spread of the *Prosopis juliflora* plant will be conducted.

A mathematical model will take into account the interactions between land and livestock populations in the spread of *Prosopis juliflora* plant. The spread process is denoted by three exclusive compartments for the land and two for animal population. In this case, we considered the approach which is similar to dynamical system as applied in epidemiological modeling and ecological modeling. The livestock is considered as the main contributor to the spread of the plant to unaffected piece of land.

3.1.1 Model Formulation

In this study a method similar to that used by Akinade *et al.* (2019) was used in their study. The significance in formulating a mathematical model of a given real life situation in our daily life is very useful in providing a deeper great understanding of the situation. For the dynamics of *Prosopis juliflora* plant, a similar approach of a dynamical system as in epidemiological modeling was used. The model is formulated by using the two populations particularly land and animals. The land involves three compartments, which are: Susceptible land (S_L), invaded land (I_L) and the reclaimed land (R_L): Whereas for the animals there are two compartments which are susceptible animals (S_A) and infestation animals (I_A). The susceptible land compartment (S_L) refer to the piece of land which is not yet invaded by the plant. The invaded land compartment (I_L) is the portion of land which has the seeds of plant that have already germinated on land and need to be reclaimed; Reclaimed land compartment (R_L) are portions of land in acres that has been invaded by the plant but is successfully being recovered by physical removal, application of chemicals, harvesting, application of leaves sprays to the plant and limitations on growing the plant excessively. As regards to animal population there are susceptible animals (S_A) which are cattle grazing in the invaded land and so are prone in ingesting the plant seeds on the land. The infected animal (I_A), are cattle that have already ingested seeds of the plant and have dropped dung on land with seeds.

3.1.2 Model Assumptions

In this model formulation, the following assumptions were made:

- (i) The plant seeds are primarily spread to susceptible land portions by grazing animals mixing is homogeneous in the considered ecosystem.
- (ii) The occurrence of natural calamities and constructions projects can take place at any compartment of land population.
- (iii) Recruitment of animals into the system is only through susceptible animal compartment by interaction.
- (iv) The land restoration should take place only on the invaded land.
- (v) The land is reclaimed from infected acres of land.

Table 1 and Table 2 describe the variables and parameters respectively used in the model.

Table 1: Five variables for both land and animal populations

Variable	Description
S_L	Is the portion of land which is not yet invaded
I_L	Is the portion of land that has already germinated and need to be restored
R_L	Are acres of land that has been invaded by the plant but is successfully recovered by various measures
S_A	Number of animals not yet infected with plant seed
I_A	Number of animals that have ingested plant seeds

Table 2: Parameters and their descriptions

Parameter	Description
Λ_1	Reclamation rate into the susceptible acres of land portions population
Λ_2	Per capita birth rate of animal population
μ_A	Per capita natural death rate of animal population
d_A	Per capita death rate of animal population induced by ingested seed
μ_L	Land portion used for constructions project and occurrence of natural calamities
ω_L	Rate of progression from invaded land to the reclaimed land
γ	Rate of recovery or restoration of infested animal into susceptible animal
γ_2	Rate of recovery or restoration of invaded land into susceptible land

3.1.3 Flow Diagram Chart

Basing the dynamics of *Prosopis juliflora* plant in animal and land population and the assumptions made, the flow diagram chart for the interactions between the plant, the land and the animals is shown in Fig. 2.

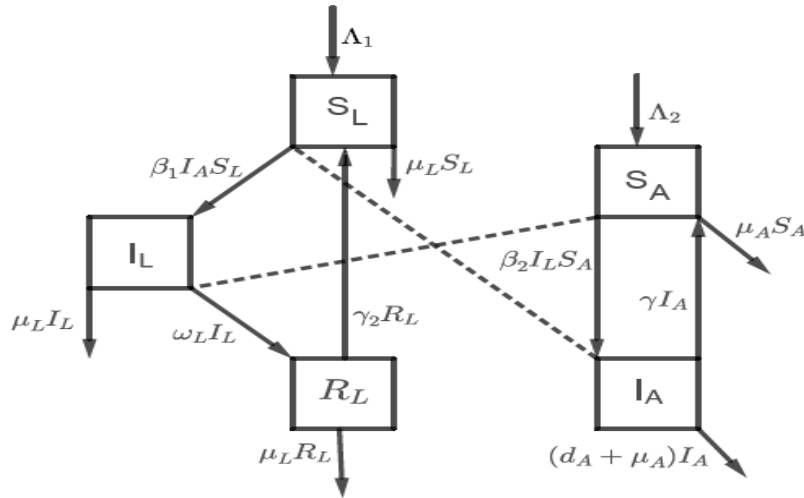

Figure 2: The flow diagram for the spread of *Prosopis juliflora* plant on piece of land by animals that ingest the plant seeds

$\beta_2 I_L S_A$ Describes the spread of *Prosopis juliflora* plant after interacting infected land and susceptible animal.

$\beta_1 \lambda_L S_L$ Describes the spread of *Prosopis juliflora* plant after interacting susceptible land and infected animal.

Model Equations: Through compartmental consideration, as in Fig. 2 depicts, we formulate the basic mathematical model which shows the dynamics for *Prosopis juliflora* plant using the following differential Equations:

$$\begin{cases} \frac{dS_L}{dt} = \Lambda_1 + \gamma_2 R_L - \beta_1 I_A S_L - \mu_L S_L \\ \frac{dI_L}{dt} = \beta_1 I_A S_L - \mu_L I_L - \omega_L I_L \\ \frac{dR_L}{dt} = \omega_L I_L - \gamma_2 R_L - \mu_L R_L \\ \frac{dS_A}{dt} = \Lambda_2 + \gamma I_A - \beta_2 I_L S_A - \mu_A S_A \\ \frac{dI_A}{dt} = \beta_2 I_L S_A - \gamma I_A - (d_A + \mu_A) I_A \end{cases} \quad (1)$$

With initial conditions:

$$S_L(0) > 0, I_L(0) \geq 0, R_L(0) \geq 0, S_A(0) > 0, I_A(0) \geq 0$$

The total size of land is given by: $N_L = S_L + I_L + R_L$ while total number of animal is given by:

$$N_A = S_A + I_A$$

3.2 Basic Properties of the Model

Under this section, we are checking if the model is mathematically and epidemiologically well posed. Furthermore, we check the existence of roundedness of the solution.

3.2.1 Positivity of Solutions

We consider Equations for S_L, I_L, R_L for land population:

Working with the reclaimed land: R_L

Recalling derivative for reclaimed land from System of differential Equation which are:

$$\frac{dR_L}{dt} = \omega_L I_L - \gamma_2 R_L - \mu_L R_L$$

$$\frac{dR_L}{dt} = \omega_L I_L - (\gamma_2 + \mu_L) R_L$$

$$\frac{dR_L}{dt} \geq -(\gamma_2 + \mu_L) R_L$$

$$\frac{dR_L}{R_L} \geq -(\gamma_2 + \mu_L) dt$$

$$\int_{R_L(0)}^{R_L(t)} \frac{dR_L}{R_L} \geq -\int_0^t (\gamma_2 + \mu_L) dt$$

$$\ln\left(\frac{R_L(t)}{R_0(0)}\right) \geq -(\gamma_2 + \mu_L)t$$

$$\left(\frac{R_L(t)}{R_0(0)}\right) \geq e^{-(\gamma_2 + \mu_L)t}$$

$$R_L(t) \geq R_0(0) e^{-(\gamma_2 + \mu_L)t} \geq 0$$

Thus, $R_L(t) \geq 0$

For Susceptible land:

$$\frac{dS_L}{dt} = \Lambda_1 + \gamma_2 R_L - \beta_1 I_L S_L - \mu_L S_L$$

$$\frac{dS_L}{dt} > -\beta_1 I_A S_L - \mu_L S_L$$

$$\frac{dS_L}{dt} > -(\beta_1 I_A + \mu_L) S_L$$

$$\frac{dS_L}{S_L} > -(\beta_1 I_A + \mu_L) dt$$

$$\int_{S_L(0)}^{S_L(t)} \frac{dS_L}{S_L} > -\int_0^t (\beta_1 I_A + \mu_L) dt$$

$$\ln\left(\frac{S_L(t)}{S_L(0)}\right) > -(\beta_1 I_A + \mu_L)t$$

$$\frac{S_L(t)}{S_L(0)} > e^{-(\beta_1 I_A + \mu_L)t}$$

$$S_L(t) > S_L(0)e^{-(\beta_1 I_A + \mu_L)t} > 0$$

$$S_L(t) > 0$$

Through applying the same technique, we get:

$$S_L(t) > 0, I_L(t) > 0, R_L(t) > 0, S_A(t) > 0, I_A(t) > 0$$

Therefore, this satisfies that $S_L(t) > 0, I_L(t) > 0, R_L(t) > 0, S_A(t) > 0, I_A(t) > 0$

3.3 Invariant Region

Invariant region is the one which shows the boundedness of the solution. To determine the region, the animal and land population we considered separately.

$$\text{For land: } N_L = S_L + I_L + R_L$$

By differentiating size of land compartment we get:

$$\frac{dN_L}{dt} = \frac{d(S_L + I_L + R_L)}{dt} = \Lambda_1 + \gamma_2 R_L - \beta_1 I_L S_L - \mu_L S_L \quad (2)$$

$$\frac{dN_L}{dt} = \frac{dS_L}{dt} + \frac{dI_L}{dt} + \frac{dR_L}{dt} = \Lambda_1 - \mu_L S_L - \mu_L I_L - \mu_L R_L$$

$$\frac{d(S_L + I_L + R_L)}{dt} = \Lambda_1 - (S_L + I_L + R_L)\mu_L$$

$$\frac{dN_L(t)}{dt} = \Lambda_1 - N_L(t)\mu_L$$

$$\frac{dN_L(t)}{dt} + \mu_L N_L(t) = \Lambda_1 \quad (3)$$

Equation (3) is the linear ode. Now to obtain the solution, the integrating factor is applied.

Thus the integrating factor $I = e^{\int \mu_L dt} = e^{\mu_L t}$

Multiplying Equation (3) with integrating factor we get:

$$e^{\mu_L t} \frac{dN_L(t)}{dt} + \mu_L N_L(t) e^{\mu_L t} = \Lambda_1 e^{\mu_L t}$$

$$\frac{d}{dt} \left(e^{\mu_L t} N_L(t) \right) = \Lambda_1 e^{\mu_L t}$$

$$d \left(N_L(t) e^{\mu_L t} \right) = \Lambda_1 e^{\mu_L t} dt \quad (4)$$

Integrating Equation (4) in both side we get:

$$\int d \left(N_L(t) e^{\mu_L t} \right) = \int \Lambda_1 e^{\mu_L t} dt$$

$$N_L(t) = \Lambda_1 + C e^{-\mu_L t}$$

$$N_L(t) = \frac{\Lambda_1}{\mu_L} + C e^{-\mu_L t} \quad (5)$$

By computing C at $t = 0$, we get:

$$C = N_L(0) - \frac{\Lambda_1}{\mu_L}$$

By substituting C Equation (5) we get:

$$N_L(t) = \frac{\Lambda_1}{\mu_L} + \left(N_L(0) - \frac{\Lambda_1}{\mu_L} \right) e^{-\mu_L t}$$

Now through considering two cases;

$$N_L(0) > \frac{\Lambda_1}{\mu_L}$$

$$N_L(0) < \frac{\Lambda_1}{\mu_L}$$

Now the boundedness condition is $N_L(t) \leq \text{Max} \left\{ N_L(0), \frac{\Lambda_1}{\mu_L} \right\}$

For animal population, we differentiate total number of animals: $N_A = S_A + I_A$ and we get:

$$\frac{dN_A}{dt} = \frac{dS_A}{dt} + \frac{dI_A}{dt} = \Lambda_2 - \mu_A S_A - (d_A + \mu_A) I_A \quad (6)$$

$$\frac{d(S_A + I_A)}{dt} = \Lambda_2 - (S_A + I_A)\mu_A - d_A I_A$$

$$\frac{d(N_A)}{dt} = \Lambda_2 - N_A \mu_A - d_A I_A$$

$$\frac{d(N_A)}{dt} + N_A \mu_A \leq \Lambda_2 \quad (7)$$

Multiplying equality (7) with integrating factor we get;

$$e^{\mu_A t} \frac{d(N_A)}{dt} + \mu_A N_A e^{\mu_A t} \leq \Lambda_2 e^{\mu_A t}$$

$$d(N_A \mu_A e^{\mu_A t}) \leq \Lambda_2 e^{\mu_A t} dt \quad (8)$$

Integrating Equation (8) in both sides we get:

$$\int d(N_A \mu_A e^{\mu_A t}) \leq \int \Lambda_2 e^{\mu_A t} dt$$

$$N_A(t) \leq \frac{\Lambda_2}{\mu_A} + C_1 e^{-\mu_A t} \quad (9)$$

Computing C_1 in (9) at $t=0 \rightarrow C_1 = N_A(t) - \frac{\Lambda_2}{\mu_A}$

$$N_A(t) \leq \frac{\Lambda_2}{\mu_A} + \left(N_A(t) - \frac{\Lambda_2}{\mu_A} \right) e^{-\mu_A t}$$

Now through considering two cases, thus

$$N_A(0) > \frac{\Lambda_2}{\mu_A}$$

$$N_A(0) < \frac{\Lambda_2}{\mu_A}$$

For animal population, the boundedness condition is $N_A(t) \leq \max \left\{ N_A(0), \frac{\Lambda_2}{N_A} \right\}$.

Therefore, the model system (1) is positive invariant in the region:

$$\Omega = \{S_L, I_L, R_L, S_A, I_A\} \in R^5 : N_L(t) \leq \max \left\{ N_L(0), \frac{\Lambda_1}{\mu_L} \right\} \text{ and } N_A(t) \leq \max \left\{ N_A(0), \frac{\Lambda_2}{N_A} \right\}$$

3.4 Model Analysis

In this analysis we to find the existence of *Prosopis* free equilibrium for the *Prosopis* dynamics and computation of its Reproduction number.

3.4.1 Existence of *Prosopis* Free Equilibrium (PFE) Point

Now PFE is obtained when we set derivatives equal to zero and $I_L = I_A = R_L = 0$ and then, we solve for S_L and S_A as follows:

$$\begin{aligned} \frac{dS_L}{dt} = \frac{dS_A}{dt} = \frac{dR_L}{dt} = \frac{dI_A}{dt} = \frac{dI_L}{dt} = 0 \\ \begin{cases} \Lambda_1 - \beta_1 S_L I_A - \mu_L S_L + \gamma_2 R_L = 0 \\ \beta_1 S_L I_A - (\mu_L + \omega_L) I_L = 0 \\ \omega_L I_L - (\gamma_2 + \mu_L) R_L = 0 \\ \Lambda_2 - \beta_2 S_A I_L + \gamma I_L - \mu_A S_A = 0 \\ \beta_2 S_A I_L - \gamma I_A - (d_A + \mu_A) I_A = 0 \end{cases} \end{aligned} \quad (10)$$

$$\Lambda_1 - \mu_L S_L = 0$$

$$\Lambda_2 - \mu_A S_A = 0 \rightarrow S_L = \frac{\Lambda_1}{\mu_L} \text{ and } S_A = \frac{\Lambda_2}{\mu_A}$$

Therefore, there exist a *Prosopis* free equilibrium (PFE)

$E^0 (S_L^0, I_L^0, R_L^0, S_A^0, I_A^0)$ which is equal to $\left(\frac{\Lambda_1}{\mu_L}, 0, 0, \frac{\Lambda_2}{\mu_A}, 0 \right)$

3.4.2 Local stability of *Prosopis juliflora* Free Equilibrium point (PFE)

In order to get local stability of (PFE), we have to show that the variation matrix $J(E_0)$ of the model system (1) has negative Eigen values (Nyerere *et al.*, 2020). Computing the differentiation of the system (1) with respect to $(S_L, I_L, R_L, S_A, I_A)$ at the *Prosopis juliflora* free equilibrium:

$$J(E_0) = \begin{pmatrix} -(\beta_1 I_L + \mu_L) & -\beta_1 S_L & \gamma_2 & 0 & 0 \\ \beta_1 S_L & -(\mu_L + \omega_L) & 0 & 0 & 0 \\ 0 & \omega_L & -(\gamma_2 + \mu_L) & 0 & 0 \\ 0 & -(\beta_2 S_A) & 0 & -(\beta_2 I_L + \mu_L) & \gamma \\ 0 & \beta_1 S_A & 0 & \beta_1 I_L & -(\gamma + d_A + \mu_A) \end{pmatrix}$$

Evaluating Jacobian at *Prosopis* Free Equilibrium point we get:

$$J|_{PFE} (1) = \begin{pmatrix} -\mu_L & -\frac{\beta_1 \Lambda_1}{\mu_L} & \gamma_2 & 0 & 0 \\ 0 & -(\mu_L + \omega_L) & 0 & 0 & 0 \\ 0 & \omega_L & -(\gamma_2 + \mu_L) & 0 & 0 \\ 0 & -\frac{\beta_2 \Lambda_2}{\mu_A} & 0 & -\mu_A & \gamma \\ 0 & \frac{\beta_1 \Lambda_2}{\mu_A} & 0 & 0 & -(\gamma + d_A + \mu_A) \end{pmatrix}$$

eigen values of Jacobian are $\lambda_1 = -\mu_L < 0, \lambda_2 = -\mu_A < 0$.

Also in the second evaluation we get:

$$J|_{PFE} (2) = \begin{pmatrix} (\mu_L + \omega_L) & 0 & 0 \\ \omega_L & -(\gamma_2 + \mu_L) \mu_L & 0 \\ \frac{\beta_1 \Lambda_2}{\mu_A} & 0 & (\gamma_2 + d_A + \mu_A) \end{pmatrix}$$

Which implies $\lambda_3 = -(\mu_L + \omega_L) < 0, \lambda_4 = -(\gamma_2 + \mu_L) < 0$ and $\lambda_5 = -(\gamma + d_A + \mu_A) < 0$.

The *Prosopis juliflora* free equilibrium for each population is locally asymptotically stable if and only if the number of secondary infections, is less than unit, that is $R_0 < 1$ and this is fact because we got negative eigen values.

3.4.3 The *Prosopis* Endemic Equilibrium Point (PEE)

The *Prosopis juliflora* endemic equilibrium PEE of the model system (1) E^* is steady solution in which the spread of the plant persists and in the solution $I_L \neq 0, R_L \neq 0, I_A \neq 0$. Now from Equation system (1) all derivatives are set equal to zero.

Let $E^* = (S_L^*, I_L^*, R_L^*, S_A^*, I_A^*)$ be the equilibrium and performing computations as follows:

$$\text{From first equation we get: } \beta_2 S_A I_L - (\gamma + d_A + \mu_A) I_A = 0 \geq I_A^* = \frac{\beta_2 \Lambda_2^* I_L^*}{\gamma \mu_A + (d_A + \mu_A)(\beta_2 I_L^* + \mu_A)}$$

From second equation we get :

$$\beta_1 S_L I_A - (\mu_L + \omega_L) I_L = 0 \geq I_L^* = \frac{\beta_1 \Lambda_1 I_A^* (\gamma_2 + \mu_L)}{\mu_L ((\gamma_2 + \mu_L)(\mu_L + \omega_L) \beta_1 I_A^* (\gamma_2 + \mu_L + \omega_L))}$$

$$\text{From third Equation we get: } \omega_L I_L - (\gamma_2 + \mu_L) R_L = 0 \geq R_L^* = \frac{\omega_L I_L^*}{\gamma_2 + \mu_L}$$

From fourth Equation we get:

$$\Lambda_1 - \beta_1 S_L^* I_A^* - \mu_L S_L^* + \gamma_2 \left(\frac{\omega_L I_L^*}{\gamma_2 + \mu_L} \right) = 0 \geq S_L^* = \frac{\Lambda_1 (\gamma_2 + \mu_L) + \gamma_2 \omega_L I_L^*}{(\beta_1 I_A^* - \mu_L)(\gamma_2 + \mu_L)}$$

$$\text{From fifth Equation we get: } \Lambda_2 + \gamma I_A^* - \beta_2 S_A^* I_L^* - \mu_A S_A^* = 0 \geq S_A^* = \frac{\Lambda_2 + \gamma I_A^*}{\beta_2 I_L^* + \mu_A}$$

$$E^* (S_L^*, I_L^*, R_L^*, S_A^*, I_A^*) =$$

$$\left[\frac{\Lambda_1 (\gamma_2 + \mu_L) + \gamma_2 \omega_L I_L^*}{(\beta_1 I_A^* - \mu_L)(\gamma_2 + \mu_L)}, \frac{\beta_1 \Lambda_1 I_A^* (\gamma_2 + \mu_L)}{\mu_L ((\gamma_2 + \mu_L)(\mu_L + \omega_L) \beta_1 I_A^* (\gamma_2 + \mu_L + \omega_L))}, \frac{\omega_L I_L^*}{\gamma_2 + \mu_L}, \frac{\Lambda_2 + \gamma I_A^*}{\beta_2 I_L^* + \mu_A}, \frac{\beta_2 \Lambda_2^* I_L^*}{\gamma \mu_A + (d_A + \mu_A)(\beta_2 I_L^* + \mu_A)} \right]$$

Because of having the values of $(S_L^*, I_L^*, R_L^*, S_A^*, I_A^*)$ as shown above which are identically positive then, there is an exist of *Prosopis* endemic equilibrium point.

3.4.4 Reproduction Number R_0 of *Prosopis juliflora* Dynamics

The basic reproduction number is the average of secondary spread of seed plant by single seed plant when introduced in an entirely susceptible land population (Diekmann *et al.*, 1990; Van den Driessche & Watmough, 2002). It determines whether the spread persists or clear out. The spread clears out when $R_0 < 1$ and persist when $R_0 > 1$ (Van den Driessche & Watmough, 2002). In computing basic reproduction number, we adopt the method similar to (Efraim *et al.*, 2018) used in their epidemiological study. In this case the similar next generation matrix method used in which new spread and transfer terms are considered. If the new spread is mathematically defined by f_i and transfer terms by v_i , then: The matrices \mathbf{F} and \mathbf{V} are given by:

$$\mathbf{F} = \frac{\partial f_i}{\partial I_i}(X) \text{ and } \mathbf{V} = \frac{\partial v_i}{\partial I_j} \text{ as defined by (Van den Driessche \& Watmough, 2002).}$$

By consideration of infested subpopulation which are:

$$\begin{cases} \frac{dI_L}{dt} = \beta_1 S_L I_A - (\mu_L + \omega_L) I_L \\ \frac{dI_A}{dt} = \beta_2 S_A I_L - (\gamma + d_A + \mu_A) I_A \end{cases} \quad (11)$$

Now we find matrix \mathbf{F} and matrix \mathbf{V} where by \mathbf{F} contains force of infestation and \mathbf{V} , is the remaining terms.

$$\text{Let } X = (I_L, I_A), f_1 = \beta_1 S_L I_A, f_2 = \beta_2 S_A I_L, V_1 = (\mu_L + \omega_L) I_L, V_2 = (\gamma + d_A + \mu_A) I_A$$

$$f(X) = \begin{pmatrix} f_1 \\ f_2 \end{pmatrix}$$

$$f(X) = \begin{pmatrix} \beta_1 S_L I_A \\ \beta_2 S_A I_L \end{pmatrix} \text{ and } \mathbf{V}(X) = \begin{pmatrix} (\mu_L + \omega_L) I_L \\ (\gamma + d_A + \mu_A) I_A \end{pmatrix}$$

By computing partial derivatives on system Equation (11) for \mathbf{F} and \mathbf{V} we get:

$$\mathbf{F} = \begin{pmatrix} \frac{\partial f_1}{\partial I_L} & \frac{\partial f_1}{\partial I_A} \\ \frac{\partial f_2}{\partial I_L} & \frac{\partial f_2}{\partial I_A} \end{pmatrix} = \begin{pmatrix} 0 & \beta_1 S_L \\ \beta_2 S_A & 0 \end{pmatrix}$$

$$\mathbf{V} = \begin{pmatrix} \frac{\partial V_1}{\partial I_L} & \frac{\partial V_1}{\partial I_A} \\ \frac{\partial V_2}{\partial I_L} & \frac{\partial V_2}{\partial I_A} \end{pmatrix} = \begin{pmatrix} \mu_L + \omega_L & 0 \\ 0 & \gamma + d_A + \mu_A \end{pmatrix}$$

Through evaluation of \mathbf{F} and \mathbf{V} at PFE we get:

$$\mathbf{F} = \begin{pmatrix} 0 & \beta_1 S_L^0 \\ \beta_2 S_A^0 & 0 \end{pmatrix} = \begin{pmatrix} 0 & \frac{\beta_1 \Lambda_1}{\mu_L} \\ \frac{\beta_2 \Lambda_1}{\mu_A} & 0 \end{pmatrix}$$

$$\mathbf{V}|_{PFE} = \begin{pmatrix} \mu_L + \omega_L & 0 \\ 0 & \gamma + d_A + \mu_A \end{pmatrix}$$

Finding the inverse of \mathbf{V} we get:

$$\mathbf{V}^{-1} = \frac{1}{(\mu_L + \omega_L)(\gamma + d_A + \mu_A)} \begin{pmatrix} \gamma + d_A + \mu_A & 0 \\ 0 & \mu_L + \omega_L \end{pmatrix}$$

en we compute \mathbf{FV}^{-1} we get:

$$\mathbf{FV}^{-1} = \begin{pmatrix} 0 & \frac{\beta_1 \Lambda_1}{\mu_L} \\ \frac{\beta_2 \Lambda_1}{\mu_A} & 0 \end{pmatrix} \begin{pmatrix} \frac{\gamma + d_A + \mu_A}{(\mu_L + \omega_L)(\gamma + d_A + \mu_A)} & 0 \\ 0 & \frac{\mu_L + \omega_L}{(\mu_L + \omega_L)(\gamma + d_A + \mu_A)} \end{pmatrix}$$

$$\mathbf{FV}^{-1} = \begin{pmatrix} 0 & \frac{\beta_1 \Lambda_1}{\mu_L (\gamma + d_A + \mu_A)} \\ \frac{\beta_2 \Lambda_1}{\mu_A (\mu_L + \omega_L)} & 0 \end{pmatrix}$$

We have to compute the Eigen values: $|\mathbf{FV}^{-1} - \lambda| = 0$

$$= \begin{pmatrix} -\lambda & \frac{\beta_1 \Lambda_1}{\mu_L (\gamma + d_A + \mu_A)} \\ \frac{\beta_2 \Lambda_1}{\mu_A (\mu_L + \omega_L)} & -\lambda \end{pmatrix}$$

$$\lambda^2 = \frac{\beta_1\beta_2\Lambda_1\Lambda_2}{\mu_A\mu_L(\mu_L + \omega_L)(\gamma + d_A + \mu_A)}$$

$$\lambda = \pm \sqrt{\frac{\beta_1\beta_2\Lambda_1\Lambda_2}{\mu_A\mu_L(\mu_L + \omega_L)(\gamma + d_A + \mu_A)}}$$

In this case the reproduction number is given by spectral radius $\rho(\mathbf{FV}^{-1})$:

$$\text{Which gives: } \rho(\mathbf{FV}^{-1}) = R_0 = \sqrt{\frac{\beta_1\beta_2\Lambda_1\Lambda_2}{\mu_A\mu_L(\mu_L + \omega_L)(\gamma + d_A + \mu_A)}} \dots\dots\dots(12)$$

3.4.5 Global Stability of *Prosopis juliflora* Free Equilibrium Point (PFE)

The Lyapunov Method and LaSalle’s Invariance Principle have been generally used to break down security of self-governing frameworks of differential conditions (Irunde *et al*, 2016; Nyerere *et al*, 2019), proposed unequivocal Lyapunov work which was utilized to break down SEIR and SEIS scourge models. Ferrera *et al*. (2017) developed a logarithmic Lyapunov capacity to examine Lotka-Volterra frameworks furthermore, later this capacity was applied by Khan *et al*. (2020) to dissect endemic equilibrium for SIR, SIRS and SIS pestilence models. Dind (2019) set forward the composite quadratic Lyapunov capacity to dissect solidness of endemic equilibrium for SIR, SIRS and SIS scourge models and later developed a composite-Volterra capacity to break down endemic equilibrium for the model with backslide. In this work we receive express Lyapunov work.

Under this part we study the global behavior of the *Prosopis* endemic equilibrium, E^* for the model system (1).

Theorem 1: The endemic equilibrium point for the *Prosopis* model System (1) is asymptotically Ω if $R_0 > 1$ stable.

Proof: We construction an explicitly Lyapunov function for the Model System (1) using (Irunde *et al*., 2016; Nyerere *et al*., 2019). Approaches as it is useful to the most of the Sophisticated Compartmental epidemiological models. In this approach, we construct Lyapunov function of the form:

$$L = \sum a_i (X_i - X_i^* \ln X)$$

Where a_i is a properly selected positive constant, X_i is the population of the i^{th} is the equilibrium level. We define the Lyapunov function candidate V for the model System (1) as:

$$L = \sum_{i=1}^5 a_i (X_i - X_i^* \ln X_i)$$

$$L = a_1 (S_L - S_L^* \ln S_L) + a_2 (I_L - I_L^* \ln I_L) + a_3 (R_L - R_L^* \ln R_L) + a_4 (S_A - S_A^* \ln S_A) + a_5 (I_A - I_A^* \ln S_A)$$

where a_1, a_2, \dots, a_6 are positive constant. The time derivative of the Lyapunov function L is given by:

$$\frac{\partial L}{\partial t} = a_1 \frac{\partial V}{\partial S_L} \cdot \frac{\partial S_L}{\partial t} + a_2 \frac{\partial V}{\partial I_L} \cdot \frac{\partial I_L}{\partial t} + a_3 \frac{\partial V}{\partial R_L} \cdot \frac{\partial R_L}{\partial t} + a_4 \frac{\partial V}{\partial S_A} \cdot \frac{\partial S_A}{\partial t} + a_5 \frac{\partial V}{\partial I_A} \cdot \frac{\partial I_A}{\partial t}$$

$$\begin{aligned} \frac{\partial L}{\partial t} = & a_1 \left(1 - \frac{S_L^*}{S_L}\right) (\Lambda_1 + \gamma_2 R_L - \beta_1 I_A S_L - \mu_L S_L) + a_2 \left(1 - \frac{I_L^*}{I_L}\right) (\beta_1 I_A S_L - \mu_L I_L - \omega_L I_L) + a_3 \left(1 - \frac{R_L^*}{R_L}\right) (\omega_L I_L - \gamma_2 R_L - \mu_L R_L) + \\ & a_4 \left(1 - \frac{S_A^*}{S_A}\right) (\Lambda_2 + \gamma I_A - \beta_2 I_L S_A - \mu_A S_A) + a_5 \left(1 - \frac{I_A^*}{I_A}\right) (\beta_2 I_L S_A - \gamma I_A - (d_A + \mu_A) I_A) \end{aligned}$$

At endemic equilibrium point:

$$\begin{aligned} \frac{\partial L}{\partial t} = & a_1 \left(1 - \frac{S_L^*}{S_L}\right) (\beta_1 I_A^* S_L^* + \mu_L S_L^* - \beta_1 I_A S_L + \mu_L S_L) + a_2 \left(1 - \frac{I_L^*}{I_L}\right) (\mu_L I_L^* + \omega_L I_L^* - \mu_L I_L - \omega_L I_L) + \\ & a_3 \left(1 - \frac{R_L^*}{R_L}\right) (\mu_L R_L^* - \mu_L R_L) + a_4 \left(1 - \frac{S_A^*}{S_A}\right) (\beta_2 I_L^* S_A^* + \mu_A S_A^* - \beta_2 I_L S_A + \mu_A S_A) + \\ & a_5 \left(1 - \frac{I_A^*}{I_A}\right) (\gamma I_A^* + (d_A + \mu_A) I_A^* - \gamma I_A - (d_A + \mu_A) I_A) \end{aligned}$$

Through rearranging the terms, we get:

$$\begin{aligned} \frac{\partial L}{\partial t} = & a_1 \left(1 - \frac{S_L^*}{S_L}\right) \left[-\beta_1 I_A S_L \left(1 - \frac{I_A^* S_L^*}{I_A S_L^*}\right) - \mu_L S_L \left(1 - \frac{S_L^*}{S_L}\right) \right] + a_2 \left(1 - \frac{I_L^*}{I_L}\right) \left[-\mu_L I_L \left(1 - \frac{I_L^*}{I_L}\right) - \omega_L I_L \left(1 - \frac{I_L^*}{I_L}\right) \right] \\ & a_3 \left(1 - \frac{R_L^*}{R_L}\right) \left[-\mu_L R_L \left(1 - \frac{R_L^*}{R_L}\right) \right] + a_4 \left(1 - \frac{S_A^*}{S_A}\right) \left[-\beta_2 I_L S_A \left(1 - \frac{I_L^* S_A^*}{I_L S_A}\right) - \mu_A S_A \left(1 - \frac{S_A^*}{S_A}\right) \right] + \\ & a_5 \left(1 - \frac{I_A^*}{I_A}\right) \left[-\gamma I_A \left(1 - \frac{I_A^*}{I_A}\right) - (d_A + \mu_A) I_A \left(1 - \frac{I_A^*}{I_A}\right) \right] \end{aligned}$$

Through simplification we get:

$$\begin{aligned} \frac{\partial L}{\partial t} = & -a_1 \mu_l \left(\frac{(S_L - S_L^*)^2}{S_L} \right) - a_2 (\mu_L + \omega_L) \left(\frac{(I_L - I_L^*)^2}{I_L} \right) - a_3 \mu_L \left(\frac{(R_L - R_L^*)^2}{R_L} \right) - a_4 \mu_A \left(\frac{(S_A - S_A^*)^2}{S_A} \right) \\ & - a_5 (\gamma + d_A + \mu_A) \left(\frac{(I_A - I_A^*)^2}{I_A} \right) + G(\Omega) \end{aligned}$$

$$\text{Where } G(\Omega) = \frac{-a_1 \beta_1 (S_L - S_L^*) (I_A S_L - I_A^* S_L^*)}{S_L} - \frac{a_4 \beta_2 (S_A - S_A^*) (I_L S_A - I_L^* S_A^*)}{S_A}$$

The function $G(\Omega)$ is a non-positive, thus $G(\Omega) \leq 0$ for all Ω . Therefore, $\frac{\partial L}{\partial t} \leq 0$ in Ω and

is zero when $\Omega = \Omega^*$, since $\frac{\partial L}{\partial t} \leq 0$ in Ω is zero when $\Omega = \Omega^*$, his implies that the largest

compact set in Ω when $\frac{\partial L}{\partial t} = 0$ is singleton $\{ \Omega^* \}$ which is the endemic equilibrium. By

Lassalle's invariant principle (Irunde *et al.*, 2016; Nyerere *et al.*, 2019), then it implies that the endemic equilibrium Ω^* is globally asymptotically stable in the interior of Ω when $R_0 > 1$, R_0 depends on the interactions of infected land and susceptible animals and ingested animal and susceptible land. The $R_0 > 1$ occurs when the interaction between interactions of infected land and susceptible animals and ingested animal and susceptible land with birth rate of animals is very high. At this point since the endemic equilibrium is stable when $R_0 > 1$ means it implies that high interaction between interactions of infected land and susceptible animals and ingested animal and susceptible land with birth rate of animals makes the endemic equilibrium to be globally asymptotically stable.

3.5 Sensitivity Analysis of basic Reproduction Number R_0

Under this section, we performed the forward sensitivity analysis of Reproduction number R_0 with respect to its parameters to determine which parameter is sensitive to the invasion of the plant on land. In finding a way of reducing the invasion of *Prosopis juliflora* plant, it is better to understand the proportional importance of factors that are reliable for the spread and eradication on the plant invasion. The forward sensitivity index of parameter μ with respect to basic Reproduction number R_0 is denoted by $\tau_{\mu_i}^{R_0}$ using the approach by Irunde *et al.* (2016) and Nyerere *et al.* (2019).

The normalized forward sensitivity index of a parameter μ_i with respect to Reproduction number R_0 is defined by:

$$\alpha_{\mu_i}^{R_0} = \frac{\partial R_0}{\mu_i} \times \frac{\mu_i}{R_0} \dots \dots \dots (13)$$

using the parameters in Table 2 and definition in Equation (13) the sensitivity indices of Reproduction number with respect to its parameters are given in Table 3.

Table 3: Sensitivity indices for R_0

Parameter	Value	Sensitivity Index
Λ_1	0.95	+ 0.5000
Λ_2	0.0902	+ 0.5000
β_1	0.000062	+ 0.5000
β_2	0.000059	+ 0.5000
μ_A	0.00237	-0.6597
μ_L	0.00548	-0.8051
ω_L	0.0035	-0.1949
d_A	0.00005	-0.00034
γ	0.005	-0.3369

The positive indices show that the basic Reproduction number is directly proportional to the values of its parameter. On the other hand, the negatives indices indicate that the basic Reproduction number is inversely proportional to the parameters.

In Table 3: $\Lambda_1, \Lambda_2, \beta_1, \beta_2$ have positive indices which are most sensitive parameters contributing in great extent in spreading the plant. Under this situation, this implies that the Reproduction number is proportional to birth rate of animals, interaction between ingested animals and Susceptible land, on other hand interaction between infected land and susceptible animals and reclamation land rate into susceptible acres of land as well. However, the negative indexed parameters are: $\mu_A, \mu_L, \omega_L, d_A$ and γ . Due to this result, the natural death rate of animals, land other uses rate most sensitive negative parameters of the model, this shows that the secondary infection of land by the plants will decrease as ingested animal deceases.

CHAPTER FOUR

RESULTS AND DISCUSSION

4.1 Results and Discussion

4.1.1 Numerical Simulation

In order to determine which parameter is sensitive to the spread of *Prosopis juliflora* plants Dynamics, we simulate the model using the parameters found in Table 3.

(i) The effects of *Prosopis juliflora* plants Dynamics on land

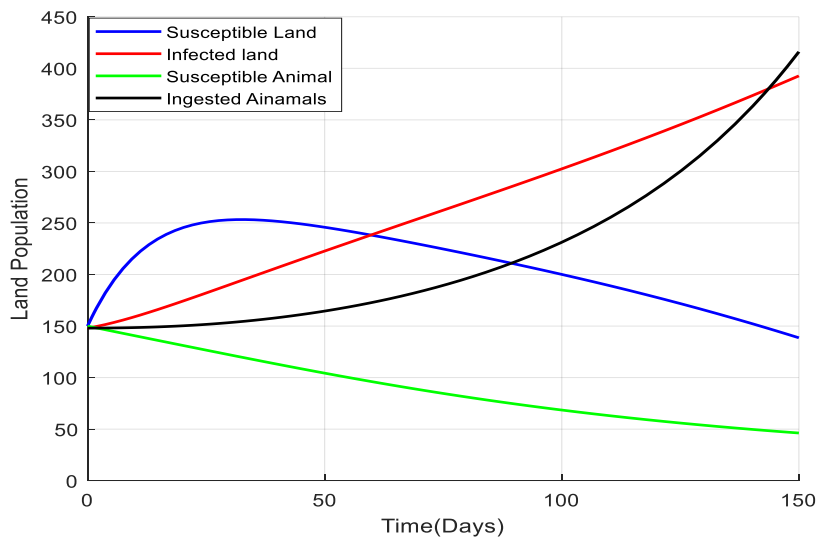

Figure 3: Dynamics of *Prosopis juliflora* Plants on Acres of Land

Figure 3 shows that the Dynamics of *Prosopis juliflora* plants on acres of land, as animals that ingested the plant increases, the susceptible land and susceptible animals decreases while infected land increases.

(ii) The effects of birth rate of animals in spreading the plant on Land

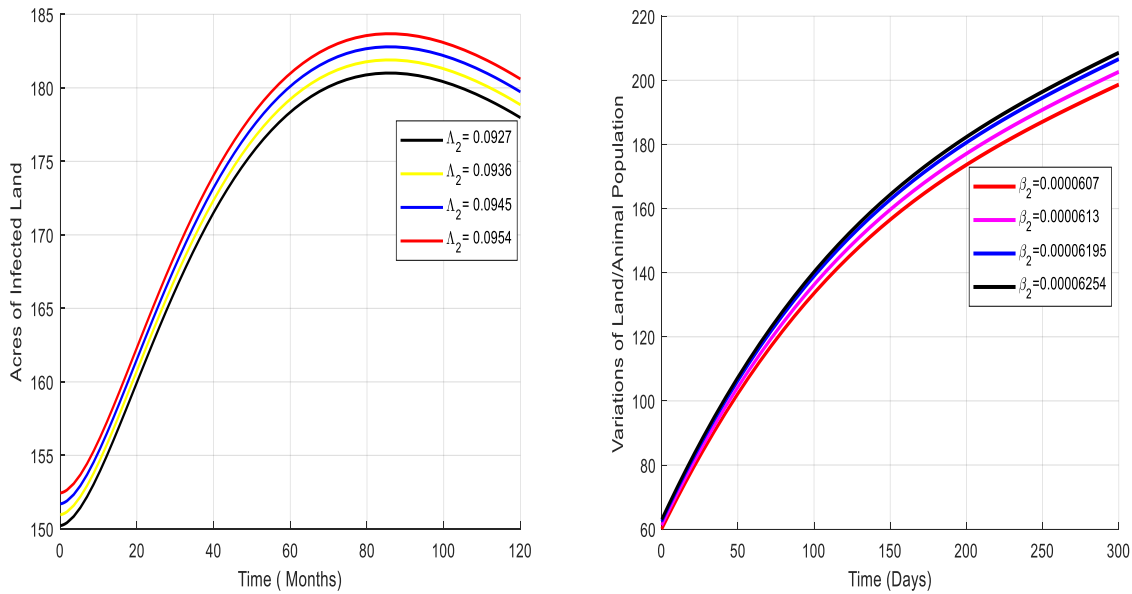

Figure 4: (a) Effects of variation of Λ_2 on Land (b) Effects of variation β_2 with infected Land

The Fig. 4 shows that as per capita birth rate of animals increase it leads to the increase of invaded land as from 152 acres of land to 183 acres within four months. This is a serious invasion of species and therefore there is need of extra efforts towards resolving the problem. On the other hand Fig. 4 (b) shows that the interaction force between the susceptible animals and the infected land as it increases it results to an increase of animals that ingested the plant.

(iii) The effects of Ingested Animals and Infected Land on susceptible land

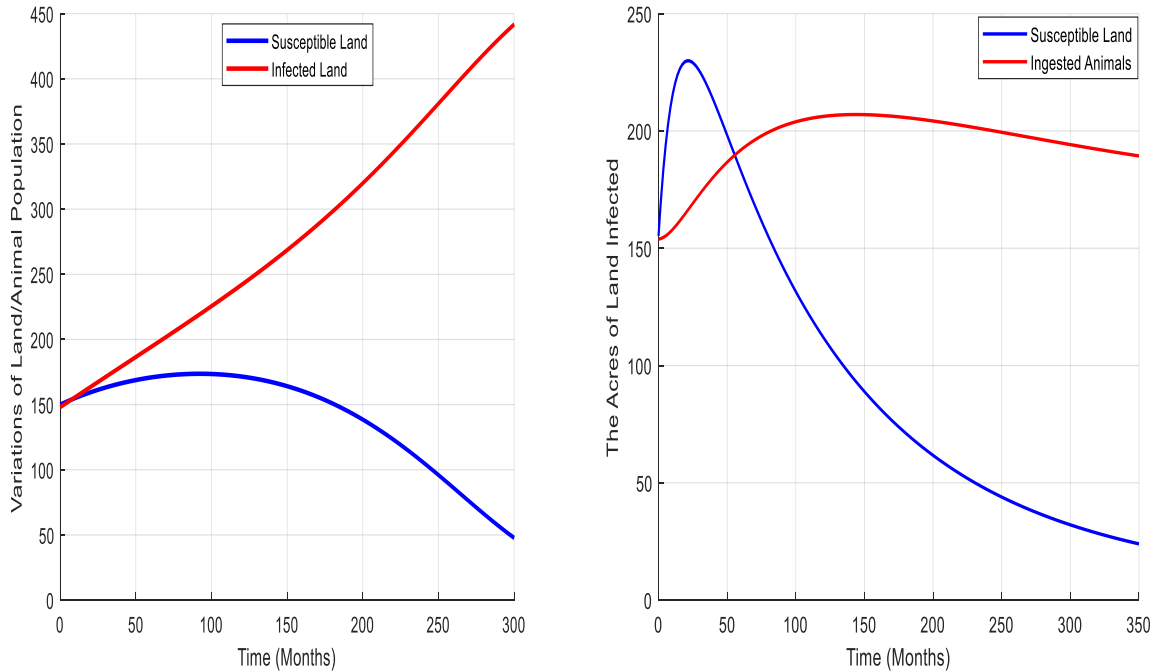

Figure 5: (a) Effects of Infested Land and Susceptible land (b) Ingested Animals and Susceptible land

Figure 5 (a) shows that as infected land increases it leads to a decrease in the susceptible land while Fig. 5 (b) shows that as animals that ingested the plant increases it results to decreases of susceptible animals. In facts both Figures shows that its relationship are inversely propotional.

(iv) The effect of ingested Animals on Acres of land

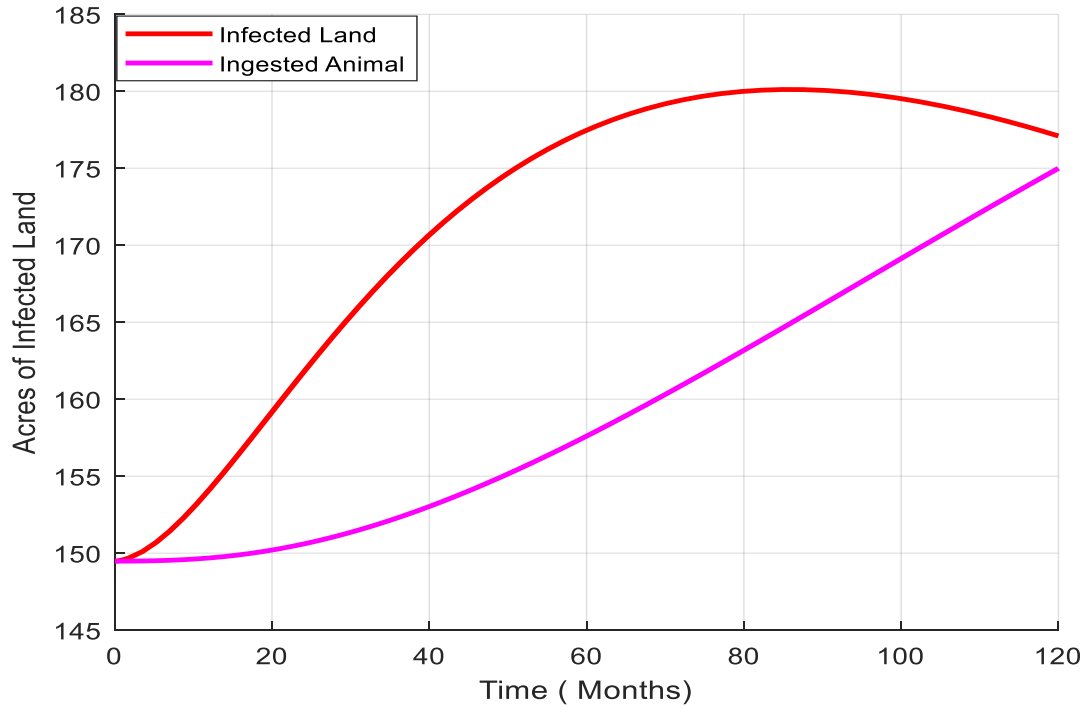

Figure 6: Variation of Ingested Animals on Acres of Land

Figure 6 shows that as number of animals that ingested the plant increases it leads to an increase of acres of infected land. Moreover, the Figure shows that within four months the area that plant infected increased from 148 acres to 178 acres an increase of 7.5 acres per month which is equal to 20 % infection or spread of the plant per month. In that case there is a need for extra effort to remedy the situation by containing the plant spread.

4.1.2 Determination impact of each of the parameters on the control of the spread of *Prosopis juliflora* plant

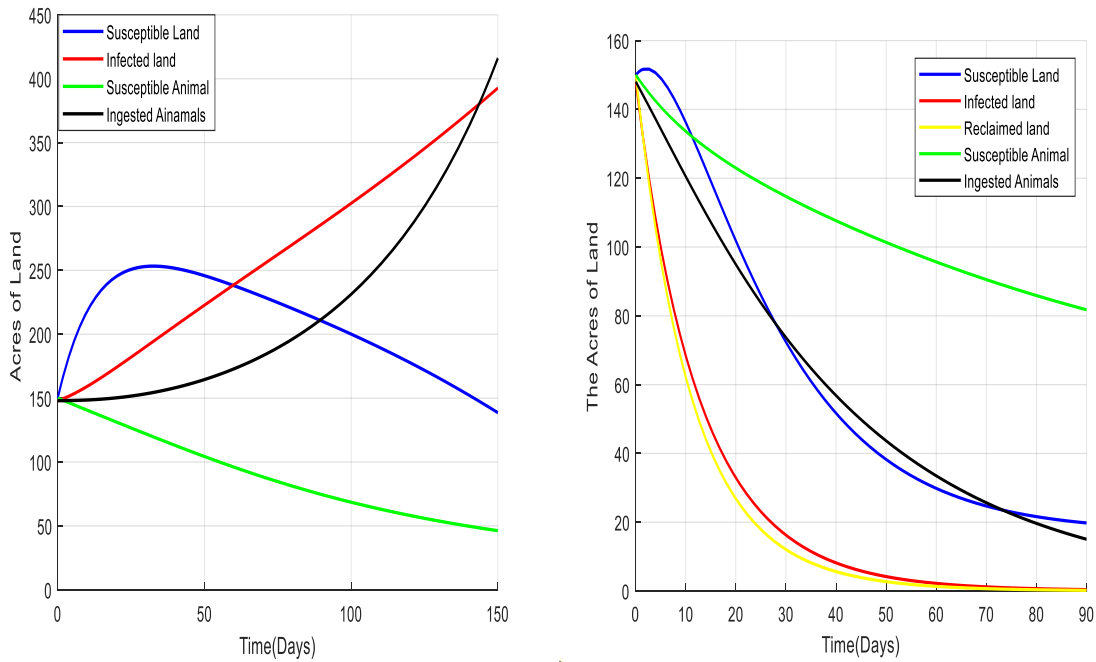

Figure 7: (a)The spread of *Prosopis Juliflora* plants before control in 1.5 Months (b)The spread of *Prosopis Juliflora* plants after control in 1.5 Months

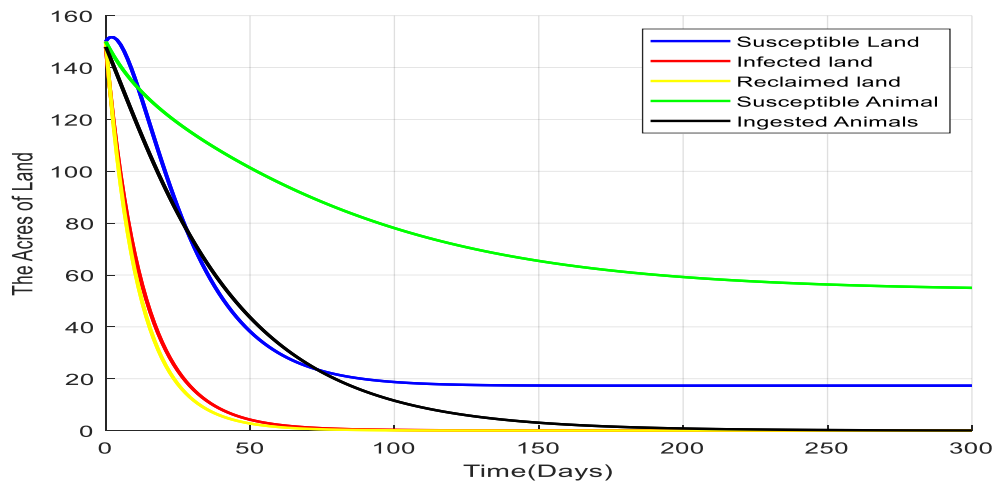

Figure 8: The spread of *Prosopis Juliflora* plants after control in 10 Months

Figure 8 Shows that the spread increased before measures were taken while Fig. 10 shows that after applying reduction and eradication measures the plant spread decreased within a short period of one month and a half. Through applying the method for long time the measures will prevent the plant from spreading as shown in Fig. 7 (b) and 8 above. Yet this was attained by varying the progression rate of invaded land to reclaimed land by sixty one point four three percent (61.43%), ω_l from 0.0035 to 0.035 through certain time as in this case ten months.

CHAPTER FIVE

CONCLUSION AND RECOMMENDATIONS

5.1 Conclusion

In this study, we used mathematical model to study *Prosopis juliflora* dynamics. The aim was to formulate and compute basic reproduction number R_0 by using next generation matrix to determine which parameter are sensitive to the plant dynamics and propose the control measure against the plant. Moreover, the equilibrium states were developed and their stability investigated. We managed to identify sensitive parameters which gives us the opportunity to propose the ways of controlling the plant. Through appropriate assumptions, we managed to formulate a mathematical model describing the spread and control of *Prosopis juliflora* plant with the aid of differential equations. Through Lyapunov function stability analysis for the equilibrium states was established whereas sensitivity analysis index for each parameter was computed by forward normalized sensitivity index method.

The deterministic model for the *Prosopis juliflora* plant dynamics with five variables and ten parameters is presented and analyzed. The study shows that when $R_0 < 1$ *Prosopis juliflora* free equilibrium is locally and asymptotically stable. On the other hand, endemic equilibrium of *Prosopis juliflora* dynamics is globally asymptotically stable when there is $R_0 > 1$.

5.2 Recommendations

Furthermore, the spread of the plant can be majorly be minimized on acres of land if the intervention are made to ensure that the endemic equilibrium of this model does not exist and when happen it should be unstable. This can be happen on the following ways:

- (i) Pastoralism communities like maasai, sukuma, kurya and farmers should be informed on the negative impacts of the plant through conducting seminars to every place where the plant invaded.
- (ii) People have to be informed on not using the plant on fens purposes because by so doing it results to rapid invasion of the plant.
- (iii) It is advisedly that at any water sources, the plant should be completely eradicated.

- (iv) Authorities particularly at the level of government should try their utmost to campaign and provide education via seminars by environmental clubs for interventions aimed at total eradication of this menace.
- (v) To facilitate policy makers and environmental stakeholders to gain a deeper and accurate understanding of safeguarding the habitat in general and autochthonous species in particular.

As regard to recommendations, the study should be the source knowledge on future research by including other agencies of plant spread such as rainfall, wind, water and people whereas conducting on cost effectiveness analysis of the control on plant invasion can be another idea of future study.

REFERENCES

- Akinade, M. O., Afolabi, A. S., & Kimathi, M. E. (2019). Mathematical Modeling and Stability Analyses of Lassa Fever Disease with the Introduction of the Carrier Compartment. *Mathematical Theory and Modeling*, 9(6)45–62. <https://doi.org/10.7176/MTM>
- Alex, P. T., Phillips, B. L., Baskett, M. L., & Hastings, A. (2013). Evolution of dispersal and life history interact to drive accelerating spread of an invasive species. *Ecology Letters*, 16(8), 1079–1087. <https://doi.org/10.1111/ele.12136>
- Aloyce, W., Kuznetsov, D., & Luboobi, L. S. (2017). A Mathematical Model for the MLND Dynamics and Sensitivity analysis in a Maize Population. *Asian Journal of Mathematics and Applications*, 2017, 1-20.
- Edward, S. (2014). Modeling and Stability Analysis for a Varicella Zoster Virus Model with Vaccination. *Applied and Computational Mathematics*, 3(4), 150-162. <https://doi.org/10.11648/j.acm.20140304.16>
- Haregeweyn, N., Tsunekawa, A., Tsubo, M., Meshesha, D., & Melkie, A. (2013). Analysis of the invasion rate, impacts and control measures of *Prosopis juliflora*: A case study of Amibara District, Eastern Ethiopia. *Environmental Monitoring and Assessment*, 185(9), 7527–7542. <https://doi.org/10.1007/s10661-013-3117-3>
- Peiris, H. O.W., Perera, S. S. N., Ranwala, S. M. W., & Chakraverty. S. (2017). Novel fuzzy based model on analysis of invasiveness due to dispersal related traits of plants. *Annals of Fuzzy Mathematics and Informatics*, 13(3), 393–401. <https://doi.org/10.30948/afmi.2017.13.3.393>
- Kilawe, C. J., Mbwambo, J., Kajembe, G., Mwakalukwa, E. E., Amri, A. M., Mushi, G. V., Sandra, E., & Eschen, R. (2017). Mrashia: *Prosopis* has started invading pastures and agricultural lands in Tanzania. *Woody Invasive Alien Species in East Africa*, (September), 1–12. <https://doi.org/10.13140/RG.2.2.34708.50568>
- Leroux, S. J., Hurford, A., Kerr, J. T., Lutscher, F., Insectarium, M., Modelling, D., & Ave, K. E. (2013). Mechanistic models for the spatial spread of species under climate change. *Ecological Applications*, 23(4), 815–828. Retrieved from <https://www.jstor.org/stable/23440928>
- Meroni, M., Ng, W. T., Rembold, F., Leonardi, U., Atzberger, C., Gadain, H., & Shaiye, M.

- (2017). Mapping *Prosopis juliflora* in West Somaliland with Landsat 8 Satellite Imagery and Ground Information. *Land Degradation and Development*, 28(2), 494–506. <https://doi.org/10.1002/ldr.2611>
- Mudavanhu, S., Blignaut, J., Vink, N., Crookes, D., & Nkambule, N. (2017). An economic analysis of different land-use options to assist in the control of the invasive *Prosopis* (Mesquite) tree. *Economic and Management Sciences*. 12(4), 366–381.
- Obiri, J. F. (2011). Tropical forests and rangelands of Kenya and Tanzania. *Jàmbá: Journal of Disaster Risk Studies*, 3(2), 151-158.
- Shackleton, R. T., Le Maitre, D. C., Van Wilgen, B. W., & Richardson, D. M. (2017). Towards a national strategy to optimise the management of a widespread invasive tree (*Prosopis* species; mesquite) in South Africa. *Ecosystem Services*, 27B, 242–252. <https://doi.org/10.1016/j.ecoser.2016.11.022>
- Shah, N. H., & Gupta, J. (2013). SEIR Model and Simulation for Vector Borne Diseases. *Applied Mathematics*, 04(08), 13–17. <https://doi.org/10.4236/am.2013.48a003>
- Tilahun, S. L., & Asfaw, A. (2013). Modeling the expansion of *Prosopis juliflora* and determining its optimum utilization rate to control the invasion in Afar Regional State of Ethiopia. *International Journal of Applied Mathematical Research*, 1(4), 726–743. <https://doi.org/10.14419/ijamr.v1i4.200>
- Zhonghua, Z., & Yaohong, S. (2014). Stability and sensitivity analysis of a plant disease model with continuous cultural control strategy. *Journal of Applied Mathematics*, 2014(2), 1-15. <https://doi.org/10.1155/2014/207959>
- Assefa, G. (2017). *Livestock Research Strategies Feeds and Nutrition, Rangelands and Animal Health*. publication.eiar.gov.et
- Diekmann, O., Heesterbeek, J. A. P., & Metz, J. A. (1990). On the definition and the computation of the basic reproduction ratio R_0 in models for infectious diseases in heterogeneous populations. *Journal of Mathematical Biology*, 28(4), 365-382.
- Eckert, S., Hamad, A., Kilawe, C. J., Linders, T. E., Ng, W. T., Mbaabu, P. R., Hailu, S., Arne W., & Schaffner, U. (2020). Niche change analysis as a tool to inform management of two invasive species in Eastern Africa. *Ecosphere*, 11(2), 1-28.

- Efrain, J. E., Irunde, J. I., & Kuznetsov, D. J. J. (2018). Modeling the transmission dynamics of anthrax disease in cattle and humans. *Journal of Mathematical and Computational Science*, 8(6), 654-672.
- Mazibuko, D. M. (2012). *Phylogenetic relationships of Prosopis in South Africa: An assessment of the extent of hybridization, and the role of genome size and seed size in the invasion dynamics*. Stellenbosch University. <https://www.google.com>
- Obiri, J. F. (2011). Invasive plant species and their disaster-effects in dry tropical forests and rangelands of Kenya and Tanzania. *Journal of Disaster Risk Studies*, 3(2), 417-428.
- Van den Driessche, P., & Watmough, J. J. M. B. (2002). Reproduction numbers and sub-threshold endemic equilibria for compartmental models of disease transmission. *Mathematical Biosciences*, 180(1-2), 29-48.

APPENDECIES

Appendix 1: Matlab Codes for Figure 3

```
function PROSOPIS_Model_Fig3 ()
clear;
clc;
lambda_1=0.95;lambda_2=0.902;gamma=0.000005;gamma2=0.070;mu_1=0.000548;
mu_A=0.00367;
beta_1=0.000062;beta_2=0.000059;omegal=0.0035;d_A=0.005;
options=odeset('RelTol',1e-4,'AbsTol',[1e-4 1e-4 1e-4 1e-4 1e-4]);
[T,Y]=ode45(@PRModeK_3,[0.005 150],[150 148 150 150 148],options);
hold on
plot(T,Y(:,1),'b',T,Y(:,2),'r',T,Y(:,4),'g',T,Y(:,5),'k','linewidth',1.5)
legend('Susceptible Land','Infected land','Susceptible Animal','Ingested Ainalams' )
xlabel('Time(Days)')
ylabel('Land Population')
grid on
hold off
function dy= PRModeK_3 (t,y)
dy=zeros(5,1);
dy(1)=lambda_1+gamma2*y(3)-beta_1*y(5)*y(1)-mu_1*y(1);
dy(2)=beta_1*y(5)*y(1)-mu_1*y(2)-omegal*y(2);
dy(3)=omegal*y(2)-gamma2*y(3)-mu_1*y(3);
dy(4)=lambda_2+gamma*y(5)-beta_2*y(2)*y(4)-mu_A*y(4);
dy(5)=beta_2*y(2)*y(5)-gamma*y(5)-(d_A+mu_A)*y(5);
end
end
```

Appendix 2: Matlab Codes for Figure 4 a

```
function PROSOPIS_Model_4()
clear;
clc;
lambda_1=0.95;lambda_2=0.902;gamma=0.00005;gamma2=0.070;mu_1=0.00548;
mu_A=0.00367;
beta_1=0.000062;beta_2=0.000059;omegal=0.0035;d_A=0.005;
options=odeset('RelTol',1e-4,'AbsTol',[1e-4 1e-4 1e-4 1e-4 1e-4]);
[T,Y]=ode45(@PRModeK_4,[0.05 120],[150 148 150 150 148],options);
hold on
plot(T,Y(:,2)*1.015,'k','linewidth',1.5)
plot(T,Y(:,2)*1.020,'y','linewidth',1.5)
plot(T,Y(:,2)*1.025,'b','linewidth',1.5)
plot(T,Y(:,2)*1.030,'r','linewidth',1.5)
xlabel('Time ( Months)')
ylabel('Acres of Infected Land')
legend('\Lambda_2= 0.0927','\Lambda_2= 0.0936','\Lambda_2= 0.0945','\Lambda_2= 0.0954')
grid on
hold off
function dy= PRModeK_4 (t,y)
dy=zeros(5,1);
dy(1)=lambda_1+gamma2*y(3)-beta_1*y(5)*y(1)-mu_1*y(1);
dy(2)=beta_1*y(5)*y(1)-mu_1*y(2)-omegal*y(2);
dy(3)=omegal*y(2)-gamma2*y(3)-mu_1*y(3);
dy(4)=lambda_2+gamma*y(5)-beta_2*y(2)*y(4)-mu_A*y(4);
dy(5)=beta_2*y(2)*y(5)-gamma*y(5)-(d_A+mu_A)*y(5);
end
end
```

Appendix 3: Matlab Codes for Figure 4 b

```
function PROSOPIS_Model_4()
clear;
clc;
lambda_1=0.95;lambda_2=0.902;gamma=0.005;gamma2=0.0070;mu_1=0.000548;mu_A=0.000
237;
beta_1=0.000062;beta_2=0.000059; omegal=0.0035;d_A=0.005;
options=odeset('RelTol',1e-6,'AbsTol',[1e-4 1e-4 1e-4 1e-4 1e-4]);
[T,Y]=ode45(@PRModeK_4,[0.05 300],[60 58 60 60 58],options);
hold on
plot(T,Y(:,4),'r','linewidth',2)
plot(T,Y(:,4)*1.02,'m','linewidth',2)
plot(T,Y(:,4)*1.04,'b','linewidth',2)
plot(T,Y(:,4)*1.05,'k','linewidth',2)
legend('\beta_2=0.0000607','\beta_2=0.0000613','\beta_2=0.00006195','\beta_2=0.00006254')
ylabel('Variations of Land/Animal Population')
xlabel ('Time (Days)')
grid on
hold off
function dy= PRModeK_4 (t,y)
dy=zeros(5,1);
dy(1)=lambda_1+gamma2*y(3)-beta_1*y(5)*y(1)-mu_1*y(1);
dy(2)=beta_1*y(5)*y(1)-mu_1*y(2)-omegal*y(2);
dy(3)=omegal*y(2)-gamma2*y(3)-mu_1*y(3);
dy(4)=lambda_2+gamma*y(5)-beta_2*y(2)*y(4)-mu_A*y(4);
dy(5)=beta_2*y(2)*y(5)-gamma*y(5)-(d_A+mu_A)*y(5);
end
end
```

Appendix 4: Matlab Codes for Figure 5 a

```
function PROSOPIS_Model_Fig5()
clear;
clc;
lambda_1=0.95;lambda_2=0.902;gamma=0.005;gamma2=0.0070;mu_1=0.000548;mu_A=0.000
237;
beta_1=0.000062;beta_2=0.000059; omegal=0.0035;d_A=0.005;
options=odeset('RelTol',1e-6,'AbsTol',[1e-4 1e-4 1e-4 1e-4 1e-4]);
[T,Y]=ode45(@PRModeK_5,[0.0 300],[150 148 150 150 148],options);
plot(T,Y(:,1),'b','linewidth',2)
plot(T,Y(:,2),'r','linewidth',2)
legend('Susceptible Land','Infected Land','Susceptible Animals','Ingested Animals' )
xlabel('Time (Months)')
ylabel('Variations of Land/Animal Population')
grid on
hold off
function dy= PRModeK_5 (t,y)
dy=zeros(5,1);
dy(1)=lambda_1+gamma2*y(3)-beta_1*y(5)*y(1)-mu_1*y(1);
dy(2)=beta_1*y(5)*y(1)-mu_1*y(2)-omegal*y(2);
dy(3)=omegal*y(2)-gamma2*y(3)-mu_1*y(3);
dy(4)=lambda_2+gamma*y(5)-beta_2*y(2)*y(4)-mu_A*y(4);
dy(5)=beta_2*y(2)*y(5)-gamma*y(5)-(d_A+mu_A)*y(5);
end
end
```

Appendix 5: Matlab Codes for Figure 5 b

```
function PROSOPIS_Model_F5()
clear;
clc;
lambda_1=0.95;lambda_2=0.0902;gamma=0.00005;gamma2=0.070;mu_1=0.00548;
mu_A=0.000367;
beta_1=0.000062;beta_2=0.000059;omegal=0.0035;d_A=0.005;
options=odeset('RelTol',1e-4,'AbsTol',[1e-4 1e-4 1e-4 1e-4 1e-4]);
[T,Y]=ode45(@PRModeK_5,[0.005 350],[150 148 150 150 148],options);
hold on
plot(T,Y(:,1)*1.035,'b','linewidth',1.5)
plot(T,Y(:,2)*1.04,'r','linewidth',1.5)
legend('Susceptible Land','Infected land')
xlabel('Time (Months)')
ylabel('The Acres of Land Infected')
grid on
hold off
function dy= PRModeK_5 (t,y)
dy=zeros(5,1);
dy(1)=lambda_1+gamma2*y(3)-beta_1*y(5)*y(1)-mu_1*y(1);
dy(2)=beta_1*y(5)*y(1)-mu_1*y(2)-omegal*y(2);
dy(3)=omegal*y(2)-gamma2*y(3)-mu_1*y(3);
dy(4)=lambda_2+gamma*y(5)-beta_2*y(2)*y(4)-mu_A*y(4);
dy(5)=beta_2*y(2)*y(5)-gamma*y(5)-(d_A+mu_A)*y(5);
end
end
```

Appendix 6: Matlab Codes for Figure 6

```
function PROSOPIS_Model_F6()  
clear;  
clc;  
lambda_1=0.95;lambda_2=0.902;gamma=0.00005;gamma2=0.070;mu_1=0.00548;mu_A=0.003  
67;  
beta_1=0.000062;beta_2=0.000059;omegal=0.0035;d_A=0.005;  
options=odeset('RelTol',1e-4,'AbsTol',[1e-4 1e-4 1e-4 1e-4 1e-4]);  
[T,Y]=ode45(@PRModel_6,[0.05 120],[150 148 150 150 148],options);  
hold on  
plot(T,Y(:,2)*1.01,'r','linewidth',2)  
plot(T,Y(:,5)*1.01,'m','linewidth',2)  
xlabel('Time ( Months)')  
ylabel(' Acres of Infected Land')  
legend('Infected Land','Ingested Animal')  
grid on  
hold off  
function dy= PRModel_6 (t,y)  
dy=zeros(5,1);  
dy(1)=lambda_1+gamma2*y(3)-beta_1*y(5)*y(1)-mu_1*y(1);  
dy(2)=beta_1*y(5)*y(1)-mu_1*y(2)-omegal*y(2);  
dy(3)=omegal*y(2)-gamma2*y(3)-mu_1*y(3);  
dy(4)=lambda_2+gamma*y(5)-beta_2*y(2)*y(4)-mu_A*y(4);  
dy(5)=beta_2*y(2)*y(5)-gamma*y(5)-(d_A+mu_A)*y(5);  
end  
end
```

Appendix 7: Matlab Codes for Figure 7 a

```
function PROSOPIS_Model_Fig7 ()
clear;
clc;
lambda_1=0.95;lambda_2=0.902;gamma=0.000005;gamma2=0.070;mu_1=0.000548;
mu_A=0.00367;
beta_1=0.000062;beta_2=0.000059;omegal=0.0035;d_A=0.005;
options=odeset('RelTol',1e-4,'AbsTol',[1e-4 1e-4 1e-4 1e-4 1e-4]);
[T,Y]=ode45(@PRModeK_7,[0.005 150],[150 148 150 150 148],options);
hold on
plot(T,Y(:,1),'b',T,Y(:,2),'r',T,Y(:,4), 'g', T,Y(:,5), 'k','linewidth',1.5)
legend('Susceptible Land','Infected land','Susceptible Animal','Ingested Ainalms')
xlabel('Time(Days)')
ylabel('quantity of acres of land/Number of animals')
grid on
hold off
function dy= PRModeK_7 (t,y)
dy=zeros(5,1);
dy(1)=lambda_1+gamma2*y(3)-beta_1*y(5)*y(1)-mu_1*y(1);
dy(2)=beta_1*y(5)*y(1)-mu_1*y(2)-omegal*y(2);
dy(3)=omegal*y(2)-gamma2*y(3)-mu_1*y(3);
dy(4)=lambda_2+gamma*y(5)-beta_2*y(2)*y(4)-mu_A*y(4);
dy(5)=beta_2*y(2)*y(5)-gamma*y(5)-(d_A+mu_A)*y(5);
end
end
```

Appendix 8: Matlab Codes for Figure 7 b

```
function PROSOPIS_Model_7b()
clear;
clc;
lambda_1=0.95;lambda_2=0.902;gamma=0.005;gamma2=0.070;mu_1=0.0548;mu_A=0.0167;
beta_1=0.000062;beta_2=0.000059;omegal=0.035;d_A=0.005;
options=odeset('RelTol',1e-4,'AbsTol',[1e-4 1e-4 1e-4 1e-4 1e-4]);
[T,Y]=ode45(@PRModel_7,[0.05 90],[150 148 150 150 148],options);
hold on
plot(T,Y(:,1),'b',T,Y(:,2),'r',T,Y(:,3),'y',T,Y(:,4),'g',T,Y(:,5),'k','linewidth',1.5)
title('A GRAPH OF LAND COMPARTMENT')
legend('Susceptible Land','Infected land','Reclaimed land','Susceptible Animal','Ingested
Ainamals' )
xlabel('Time(Days)')
ylabel('The Acres of Land Population')
hold off
function dy= PRModel_7 (t,y)
dy=zeros(5,1);
dy(1)=lambda_1+gamma2*y(3)-beta_1*y(5)*y(1)-mu_1*y(1);
dy(2)=beta_1*y(5)*y(1)-mu_1*y(2)-omegal*y(2);
dy(3)=omegal*y(2)-gamma2*y(3)-mu_1*y(3);
dy(4)=lambda_2+gamma*y(5)-beta_2*y(2)*y(4)-mu_A*y(4);
dy(5)=beta_2*y(2)*y(5)-gamma*y(5)-(d_A+mu_A)*y(5);
end
end
```

Appendix 9: Matlab Codes for Figure 8

```
function PROSOPIS_Model_8()
clear;
clc;
lambda_1=0.95;lambda_2=0.902;gamma=0.005;gamma2=0.070;mu_1=0.0548;mu_A=0.0167;
beta_1=0.000062;beta_2=0.000059;omegal=0.035;d_A=0.005;
options=odeset('RelTol',1e-4,'AbsTol',[1e-4 1e-4 1e-4 1e-4 1e-4]);
[T,Y]=ode45(@PRModel_8,[0.05 300],[150 148 150 150 148],options);
hold on
grid on
plot(T,Y(:,1),'b',T,Y(:,2),'r',T,Y(:,3),'y',T,Y(:,4),'g',T,Y(:,5),'k','linewidth',1.5)
legend('Susceptible Land','Infected land','Reclaimed land','Susceptible Animal','Ingested
Animals' )
xlabel('Time(Days)')
ylabel('Quantity of acres of land/ Number of animals')
hold off
function dy= PRModel_8 (t,y)
dy=zeros(5,1);
dy(1)=lambda_1+gamma2*y(3)-beta_1*y(5)*y(1)-mu_1*y(1);
dy(2)=beta_1*y(5)*y(1)-mu_1*y(2)-omegal*y(2);
dy(3)=omegal*y(2)-gamma2*y(3)-mu_1*y(3);
dy(4)=lambda_2+gamma*y(5)-beta_2*y(2)*y(4)-mu_A*y(4);
dy(5)=beta_2*y(2)*y(5)-gamma*y(5)-(d_A+mu_A)*y(5);
end
end
```

RESEARCH OUTPUTS

(i) Publications

Simon, J., Mirau, S., & Luboobi, S. L. (2020). A deterministic Model for the Control of Spread of *Prosopis juliflora* Plants. *Journal of Mathematics and Informatics*, 19(2020), 93-114.

(ii) Poster Presentation
