

2021-08

# IoT-based system for automated floodwater detection and early warning in the East Africa Region: a case study of Arusha and Dar es salaam, Tanzania

Uwayisenga, Ange

NM-AIST

---

<https://doi.org/10.58694/123456789/1340>

*Provided with love from The Nelson Mandela African Institution of Science and Technology*

**IoT-BASED SYSTEM FOR AUTOMATED FLOODWATER  
DETECTION AND EARLY WARNING IN THE EAST AFRICA  
REGION: A CASE STUDY OF ARUSHA AND DAR ES SALAAM,  
TANZANIA**

**Ange Josiane Uwayisenga**

**A Dissertation Submitted in Partial Fulfilment of the Requirements for the Degree of  
Master of Science in Embedded and Mobile Systems of the Nelson Mandela African  
Institution of Science and Technology**

**Arusha, Tanzania**

**August, 2021**

## **ABSTRACT**

Climate change is a major cause of the increase of environmental natural disasters like floods, droughts, and storms. Although several countries have been affected by such natural disasters, the East African region is one of the most affected. This work focuses on floods as the most frequent disaster in the East African region where 280 died and about 2.8 million people were affected from the floods that occurred in 2019 alone. Different techniques have since been developed to mitigate the effects of floods. However, the methodologies used have not responded to the identified problems that include lack of community awareness, information inadequacy, and low-cost systems. To solve these problems, the present study aims at developing a low-cost system that detects and alerts the community on upcoming flood incidents. The proposed floodwater detection and early warning system comprise of three units. The sensing unit continuously monitors environmental parameters using ultrasonic, temperature and humidity sensors. The processing unit processes and analyses the collected data from sensors then, the alerting unit alerts the community and local authorities using a buzzer and a Short Message Service notification. The system uses the Global System for Mobile Communication to provide internet connectivity which enables data to be collected, stored, and monitored in the cloud. The system was implemented at Themis river and results showed that floods can be detected and the community near the flood-prone area alerted early. Therefore, the use of the developed system in flood-prone areas can contribute to environmental disaster risk mitigation.

## DECLARATION

I, Ange Josiane Uwayisenga, do hereby declare to the Senate of the Nelson Mandela African Institution of Science and Technology that this dissertation is my original work and that it has neither been submitted nor being concurrently submitted for a similar degree award in any other institution.

Ange Josiane Uwayisenga



Name and Signature of the candidate

05/08/2021

Date

The above declaration is confirmed by

Dr. Neema Mduma



Name and Signature of supervisor 1

06-08-2021

Date

Dr. Mussa Ally



Name and Signature of the supervisor 2

6<sup>th</sup> August 2021

Date

## **COPYRIGHT**

This dissertation is a copyright material protected under the Berne Convention, the Copyright Act of 1999 and other international and national enactments, in that behalf, on intellectual property. It must not be reproduced by any means, in full or in part, except for short extracts in fair dealing; for researcher private duty, critical scholarly review or discourse with an acknowledgement, without the written permission of the office of Deputy Vice Chancellor for Academic, Research and Innovation on behalf of both the author and Nelson Mandela African Institution of Science and Technology.

## CERTIFICATION

The undersigned certify that, they have read and hereby recommend for acceptance by the Nelson Mandela African Institution of Science and Technology a dissertation titled, "*IoT Based System for Automated Floodwater Detection and Early Warning in the East Africa Region: A case of Study of Arusha and Dar er Salaam, Tanzania*" in partial fulfilment of the requirements for the degree of Masters of Science in Embedded and Mobile Systems of the Nelson Mandela African Institution of Science and Technology.

Dr. Neema Mduma



**Name and Signature of supervisor 1**

06-08-2021

**Date**

Dr. Mussa Ally



**Name and Signature of the supervisor 2**

6<sup>th</sup> August 2021.

**Date**

## **ACKNOWLEDGEMENTS**

Praised to God the Almighty for His blessings. With His consent I probably would not be able to finish this final year project including this dissertation on time. I have successfully accomplished what I have set according to the plan. Here, I would like to take this opportunity to express my appreciation for the continuous support that I have received from my sponsor CENIT@EA, the mentorship from lecturers at Nelson Mandela African Institution of Science and Technology throughout the year in order to finish this research project successfully.

I am ineffably indebted to Dr. Mussa Ally and Dr. Neema Mduma, my supervisors for their conscientious advice, assistance and encouragement throughout the entire procedure to complete this project. I extend my appreciation to Dr. Ramadhani Sinde for his support through advice and suggestions to improve my project prototype in order to produce an outstanding product.

I am extremely thankful and pay my gratitude to my industry host supervisor, the Director of Productive Sectors and the Department of Environmental and Natural Resources at East Africa Community Secretariat for the insights and facilitations provided throughout my internship period while working on this project.

At last but not least appreciation goes to my family members, advisors and friends who directly and indirectly supported me morally as well as in any another way. I really appreciate all your kindness and your time.

## **DEDICATION**

In memory of my late father, Joseph Azakurishaka.



## TABLE OF CONTENTS

ABSTRACT.....	i
DECLARATION .....	ii
COPYRIGHT.....	iii
CERTIFICATION .....	iv
ACKNOWLEDGEMENTS.....	v
DEDICATION.....	vi
TABLE OF CONTENTS.....	vii
LIST OF TABLES .....	x
LIST OF FIGURES .....	xi
LIST OF APPENDICES.....	xiii
LIST OF ABBREVIATIONS AND SYMBOLS .....	xiv
CHAPTER ONE.....	1
INTRODUCTION .....	1
1.1 Background of the problem.....	1
1.2 Statement of the problem.....	2
1.3 Rational of the study.....	2
1.4 Research Objectives .....	3
1.4.1 General objective .....	3
1.4.2 Specific objectives .....	3
1.5 Research questions .....	3
1.6 Significance of the study .....	3
CHAPTER TWO.....	5
LITERATURE REVIEW .....	5

2.1	Flooding.....	5
2.2	Types of flooding .....	5
2.2.1	River floods.....	5
2.2.2	Pluvial Flooding.....	6
2.3	General flood impacts in health and socio-economic sectors .....	7
2.4	Flooding status in East Africa region .....	8
2.5	Related Works .....	10
CHAPTER THREE .....		13
MATERIALS AND METHODS.....		13
3.1	Material.....	13
3.1.1	Case study .....	13
3.1.2	Data collection .....	15
3.1.3	Distance detected calculations .....	16
3.1.4	Stages considered for flood detection and monitoring .....	17
3.2	Methods .....	18
3.2.1	Software Development Model used.....	18
3.2.2	System design and specification .....	20
3.2.3	Description of electronics devices used.....	22
3.2.4	System implementation.....	26
3.2.5	System testing .....	30
CHAPTER FOUR.....		34
RESULTS AND DISCUSSIONS.....		34
4.1	Results .....	34
4.1.1	Lab-testing approach results .....	34
4.1.2	Field-testing approach results .....	38

4.2 Discussions .....	41
CHAPTER FIVE .....	42
CONCLUSION AND RECOMMENDATIONS .....	42
5.1 Conclusion.....	42
5.2 Recommendations .....	42
REFERENCES .....	44
APPENDICES .....	50
RESEARCH OUTPUT.....	57

## LIST OF TABLES

Table 1:	River depth measurements .....	16
Table 2:	Water level stages .....	18
Table 3:	Comparison between the agile and waterfall software development models. ....	18
Table 4:	Comparison statements used for lab testing approach.....	34
Table 5:	Initial numerical outputs and corresponding water level indication status from serial monitor window during Lab testing approach conditions .....	35
Table 6:	Developed system attributes .....	40

## LIST OF FIGURES

Figure 1: River Flooding (Zurich company, 2019) .....	6
Figure 2: Flash flooding (Zurich company, 2019) .....	6
Figure 3: East Africans affected by flood incident (2016-2020).....	8
Figure 4: Mostly affected East Africa countries in 2020 .....	9
Figure 5: Houses submerged into water (John <i>et al.</i> , 2019).....	14
Figure 6: Themis river in Arusha towards downstream direction .....	14
Figure 7: Tape measure .....	15
Figure 8: Msimbazi river depth measurement process.....	15
Figure 9: Agile software development process .....	19
Figure 10: Waterfall software development model .....	19
Figure 11: System architecture .....	21
Figure 12: Block diagram of the developed system .....	22
Figure 13: Arduino Uno .....	22
Figure 14: Ultrasonic Sensor HC-SR04 .....	23
Figure 15: DHT22 Humidity and Temperature Sensor .....	24
Figure 16: GSM Module SIM808 .....	25
Figure 17: Buzzer .....	25
Figure 18: 16x2 LCD module.....	26
Figure 19: Circuit diagram of the developed system.....	27
Figure 20: Schematic diagram of the developed system.....	28
Figure 21: ThingSpeak IoT Cloud Website.....	29
Figure 22: Flowchart of the developed system.....	30
Figure 23: Connection of hardware components used in lab testing approach.....	31
Figure 24: Prototype development .....	32
Figure 25: System installed at the field .....	32
Figure 26: Visualization of data from the ultrasonic sensor.....	35
Figure 27: Visualization of humidity data from the DHT22 sensor.....	36
Figure 28: Visualization of temperature data from the DHT22 sensor .....	36
Figure 29: SMS notification .....	37
Figure 30: Water level status indicator .....	37
Figure 31: Display of the water level condition .....	38

Figure 32: Visualization of data from the ultrasonic sensor.....	39
Figure 33: Visualization of humidity data from the DHT22 sensor.....	39
Figure 34: Visualization of temperature data from the DHT22 sensor .....	40

## LIST OF APPENDICES

Appendix 1: Program source code .....	50
Appendix 2: System installation in the field (Themí river).....	55
Appendix 3: Certificate of publication .....	56

## **LIST OF ABBREVIATIONS AND SYMBOLS**

DRRM	Disaster Risks Reduction and Management
EAC	East Africa Community
GSM	Global System for Mobile Communication
HTTP	Hypertext Transfer Protocol
IAD	Intergovernmental Authority on Development
IDE	Integrated Development Environment
IoT	Internet of Things
LCD	Liquid Crystal Display
LED	Light Emitting Diode
NASA	National Aeronautics and Space Administration
OCHA	United Nations Office for the Coordination of Humanitarian Affairs
PCB	Printed Circuit Board
PCV	Polyvinyl Chloride
SMS	Short Message Service
UN	United Nations
USB	Universal Serial Bus



# CHAPTER ONE

## INTRODUCTION

### 1.1 Background of the problem

Climate change is currently one of the most serious and extreme issues worldwide. Besides the contribution of human activities to climate change, the planet's climate is changing now much more than ever (Banuri, 2009). Due to climate-related and geophysical disasters, a total of 1.3 million people have died between 1988 and 2017, and a further 4.4 billion injured, homeless, and displaced (Tingsanchali, 2012). Although a greater number of these disasters were due to geophysical events like earthquakes and tsunamis, 91 % of all documented disasters due to natural hazards resulted from floods, droughts, tropical cyclones, heatwaves, and other excessive weather events (Wallemacq *et al.*, 2018). The effects of climate change are anticipated to further increase due to the general change and variability of climate.

Among the natural disasters, floods are the most frequent and dangerous with adverse effects on the society (Sholihah *et al.*, 2020). Flooding has drastically impacted lives and livelihoods for countries located in Sub- Sahara Africa and most vulnerable due to climatic fluctuations (Armah *et al.*, 2010). According to the report of the United Nations Office for the Coordination of Humanitarian Affairs (OCHA) of 2019, the East Africa region continues to suffer from flooding more than any other region. In the 2019 flood incidents alone, an estimated 2.8 million people were affected and over 280 people died in the region. Also, from March to May 2020 several Africans' countries, particularly in East Africa, have been experiencing an unusual heavy rainfall that led to transboundary flooding and food shortage (NASA, 2020). The vulnerable settlements neighboring riverbanks have been affected and hundreds of people living near the flood prone areas lost their lives.

Like other countries in the region, Tanzania continues to face the impacts of exorbitant incidents like floods and unusually heavy rainfall, particularly in its Central and Northern regions. These frequent incidents have impacted people's lives resulting in deaths, damage of property, infrastructure, disruption of agricultural activities, and damage to human health and general well-being (Ptz, 2020). Dar es Salaam is one of the cities in Tanzania that has faced the worst negative impacts of flooding, including inaccessibility and unavailability of quality water (Smiley & Hambati, 2019). Other factors that have been identified as the primary

contributing factors to flood events are human activities such as improper land use (Kalkan & Akar, 2010), desertification, and aggravation of drainage systems.

Disaster risk reduction and management are among the currently existing programs in the East African Community (EAC Secretariat, 2012). Taking advantage of technological advancements, various mechanisms were developed to assess floods risks, detect and monitor floods at different flood-prone areas. However, the lack of a system to enhance community awareness on upcoming flood incidents remains a challenge.

## **1.2 Statement of the problem**

Flood is one of the usual and serious disaster in EAC region and its occurrence is increasing in every state (EAC Secretariat, 2012). The heavy rainfall is the main factor that caused flood events and the increase may become more frequent due to the climate variations (Wainwright *et al.*, 2020). During flood event, rivers and other prone areas become overflowed and people's lives are affected including both injuries and deaths, property and infrastructure damage.

Various researches on flood incidents have been previously conducted and different techniques have been developed to optimize flood detection, forecasting and warning. However, the challenge of inadequate and accurate information were not addressed (Peng & Hsu, 2018). The lack of awareness on the upcoming flood incident for the community living closely to the prone area is also a challenge (Do *et al.*, 2016). The method used in detecting water level was not accurate due to the fact that local environmental parameters such as temperature and humidity were not considered (Peng & Hsu, 2018). Furthermore, some of the current existing systems are not cost effective due to the equipment and algorithms used in their development process and hence they are rarely used in different flood-prone areas in the region.

Therefore, the proposed IoT based system for automated floodwater detection and early warning will solve the presented gaps from existing systems by developing a low-cost system that increases the community awareness and provides adequacy and accurate information on the upcoming flood incident.

## **1.3 Rational of the study**

Flood is a major challenge that most countries in East Africa region have been facing. It has remarkably noticed that flood incident occurs in location with and without water bodies and affects people and the economy of the country as well. The existing mechanisms in the region,

have been mainly deployed at transboundary water bodies. Therefore, there is a need to develop a low cost system that can be deployed in all possible flood-prone areas at local and national levels within a country.

## **1.4 Research Objectives**

### **1.4.1 General objective**

The main objective of this project was to develop an IoT-based system for timely flood detection and early alerts to the community living in or close to flood-prone areas in East Africa region.

### **1.4.2 Specific objectives**

To attain the main objective, the following specific objectives were performed:

- (i) Analyzation of the requirements for developing an automated floodwater detection and early warning system.
- (ii) Design and development of an automated floodwater detection and early warning system.
- (iii) Validation and implementation of the developed system at a particular targeted flood-prone area.

## **1.5 Research questions**

- (i) What is the main river parameter to consider in detecting water level?
- (ii) Which method can be used to increase the community awareness on the upcoming flood incident especially in rural areas?
- (iii) How did the developed system detect flood using specified ultrasonic sensor?

## **1.6 Significance of the study**

The flood happens so quickly and it is not easy to manage. Thus, the increase of awareness to the community on the upcoming flood incident will contribute to the disaster risk mitigation so as reducing high number of people dying, property and infrastructure damage caused by the flood incident. Vital information on flood incident in a particular area will be provided to the local authorities within a country and hence helping them to act fast and undertake long term

sustainable solutions to prevent against the flood. The system will also contribute to EAC current program of mitigating the impacts of disaster through EAC Disaster Risks Reduction and Management (DRRM) including early warning systems. Therefore, results of this study is of paramount importance both to the community and the countries in the region as well.

## **CHAPTER TWO**

### **LITERATURE REVIEW**

#### **2.1 Flooding**

Flooding is defined as a weather related disaster that broadly faced by the entire world. It frequently occurs due the heavy rainfall which causes the water from different water bodies to overflow onto the dry land. The flood harmful is mostly resulted from the debris carries including vehicles, trees and buildings. However, due to the speed of water flowing, the community can also be harmed (Samuels, 2013). Flooding can occur in rural and urban areas with or without water bodies and leaves impacts on the community living close to the prone areas.

#### **2.2 Types of flooding**

Flood may occur in different forms such as storm, river, pluvial, and coastal. it is more important to identify and understand the type of flood occurring in a specific prone area for an effective flood risks prevention and mitigation as they always occur in different forms, cause different impacts and have dissimilar precaution and safety measures (Zurich company, 2019). Although there are different forms of flood, it has been remarkably noticed that river floods are the most usual natural hazards causing harmful and constant impacts worldwide than other types of floods (UNOOSA/UN-SPIDER., 2020).

##### **2.2.1 River floods**

River or fluvial flooding is a common flood event that takes place when the water level in the river and other water bodies such as lake and stream overflows onto nearby land, surrounding banks and shores. Various models have been taken into account to determine the possibility of river flooding occurrence including consideration of past and forecasted precipitations; active water levels; duration and capacity of rainfall in the watershed area (Zurich company, 2019; Maddox, 2014). However, the effects caused by this type of flood are expected to increase due to the rapid and frequent climate change.

## Fluvial floods (river floods)

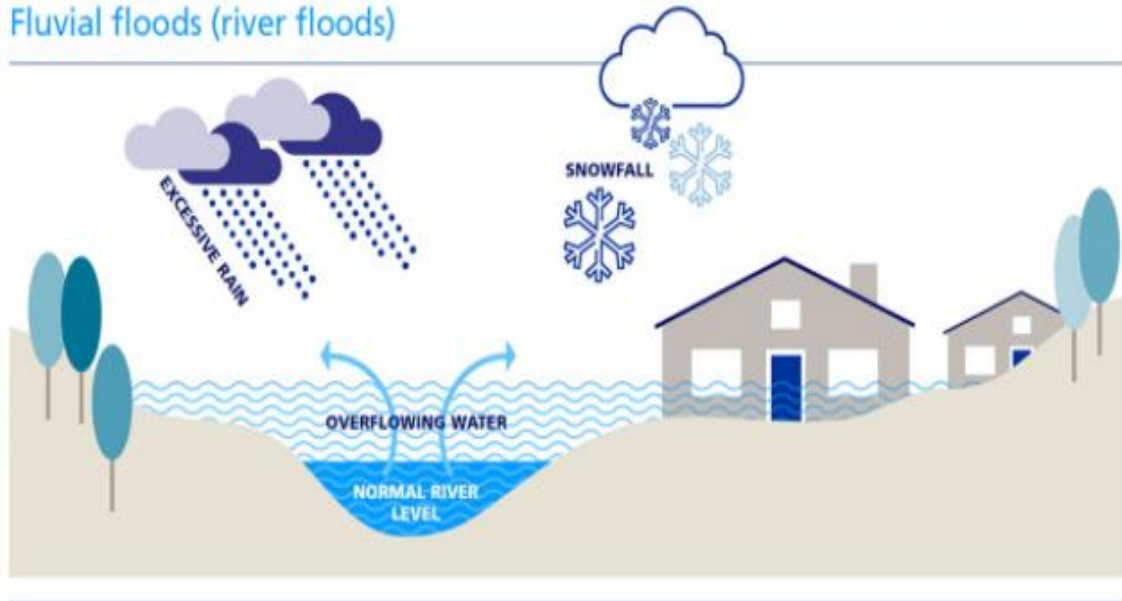

Figure 1: River Flooding (Zurich company, 2019)

### 2.2.2 Pluvial Flooding

Pluvial flood is another type of flooding that can occur in urban and rural areas with or without water bodies in their proximity. The community does not require to be in water body's proximity to be affected (Maddox, 2014; Zurich company, 2019). Pluvial floods occur independently of an abounding river or other water bodies due to the excessive heavy rainfall, improper land use and drainage systems. The risk bestowed by pluvial flooding has come into view as a crucial matter in inner-city water supervisory (Rosenzweig *et al.*, 2018).

## Pluvial floods (flash floods and surface water)



Figure 2: Flash flooding (Zurich company, 2019)

Pluvial flooding may occur in two different forms which are surface water and flash floods. Surface water floods occur when the inner-city drainage system become submerged and causes the water to flow out into the streets and adjacent structures (Africa, 2020; Maddox, 2014; Zurich company, 2019). This kind of flood occurs gingerly where people can get time to evacuate and save their lives. While the surface water flooding does not have an immediate effect on people's lives, but it may cause noteworthy economic damage. The Flash floods are depicted by an extreme, lofty quickness inundation of water triggered by rain falling within a short time in the proximity of elevated ground. They can also occur due to an unexpected release of water from upriver dam or levee. Flash floods are quite threatening and devastating not only due to the energy of water but also speeding debris that is frequently cleared out in the flow (Zurich company, 2019).

### **2.3 General flood impacts in health and socio-economic sectors**

Flood event happens too fast and the victims don't get enough time to escape from immediate effects. During flood incident, people can be healthily and socio-economically affected. People can directly be affected by the flood incident especially when they are trying to evacuate including drowning that leads to death, animal bites and the water flowing which frequently carries the debris such as trees and vehicles (Mohamed *et al.*, 2017). This may be seen from flood risks that people can face after the incident including disability, malnutrition, infectious diseases, poor mental health and poverty (Du *et al.*, 2010).

In centuries, people used to settle near rivers, benefit from flat land and access to water needed to sustain life in agricultural and farming related activities. Due to the rapid increase of population growth, socio-economic activities in flood-prone areas and exceptional climate fluctuations, the prevalence and effect of flood have increased worldwide (Svetlana *et al.*, 2015). Flood event can directly and indirectly affect both agricultural and industrial activities in floodplain areas such as crops destruction, buildings damage, yield reduction, loss of added value due to inaccessibility of production factors and infrastructure damage (Brémond & Grelot, 2013). All this affects the socio-economic development of a country and worldwide as well.

Different standards were considered to determine the extremity of the river and pluvial flooding; fight against the health and economic effects caused by flood incident on the society. However, this can not completely prevent the flood and remove impacts that the community

are facing. Therefore, the significant measures including early warning systems are indeed important to increase the community awareness of the upcoming incident and restoring actions in floodplain.

## 2.4 Flooding status in East Africa region

Cities in Africa are the rapidest enlarging in the world where the population growth, inadequate infrastructure and insufficient vegetation may cause the increase of flood risk. The flood's effects are variably felt by all the community and the cost of the flooding impacts is expected to raise every year. The financial resources, people's lives and their well-being will continuously be affected in case this issue is not taken into consideration. Flooding is one of the catastrophe natural endangerment in East Africa region due to climate change and variability, the rate of occurrence and flood gravity as the way up is predictably to become worse (Africa, 2020).

According to UN report, the number of victims affected by rain seasonal flooding has increased from year 2016 to 2020 for more than five times. The Fig. 3 shows that in East Africa countries, the number of people affected by flood incident in 2016 was 1.1 million. The incident became calamity in 2020, where close to six million people were affected (Catherine, 2020).

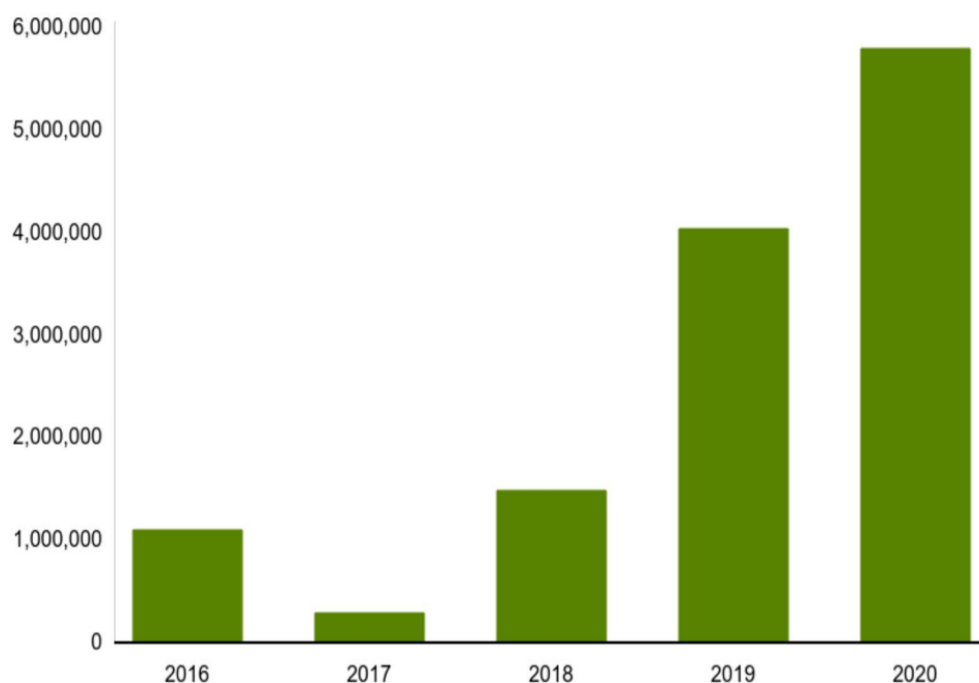

**Figure 3: East Africans affected by flood incident (2016-2020)**



Many countries constituting East Africa region have been recently affected by flood event which caused human fatalities, injuries, displacement, property and agricultural activities damage. In the region, some countries including Burundi, Kenya, Ethiopia, southern Somalia, Uganda and coastal Tanzania experienced the heaviest rainfall from April 11<sup>th</sup> to 20<sup>th</sup>, 2020 where anomalies in excess of 50-200 millimeters (mm) were derived by the satellite (Messages & Progress, 2020). River and flash flood are the most type of flood that have been regionally occurred and left effects on people’s lives, communities and businesses. The Fig.4 shows the most affected countries by floods in East Africa region in 2020.

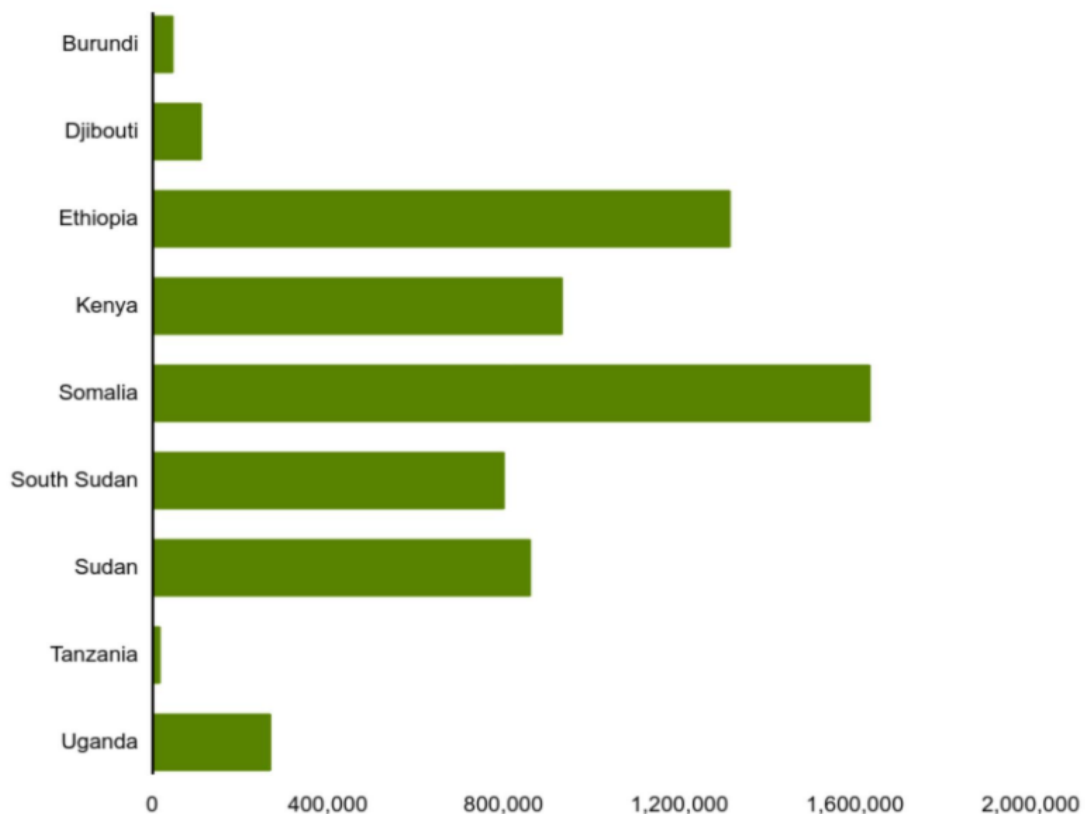

**Figure 4: Mostly affected East Africa countries in 2020**

On the report of Intergovernmental Authority on Development (IAD) climate center, the extreme heavy rainfall has been driven by the Ocean Indian Dipole and it is in its strongest positive state since 2006 (Geography, 2016). Flood is not an incident which can be completely prevented without actions taken at local and regional levels. Thus, a successful implementation of the proposed system in selected rivers located in Tanzania will ensure the effective system deployment and adaptation in any other country within the region. Furthermore, it will

contribute in disaster risk reduction management strategies established within the country in the region including flood event as well.

## **2.5 Related Works**

Flood events are a challenging natural disaster which impacts on the sustainable environmental, social and economic development of a country (Mata *et al.*, 2013). Several studies were conducted to assess and analyze flood risks. Taking advantage of technological advancements, various mechanisms were developed to detect and monitor floods at different flood-prone areas.

Flood risk assessment was used to find out the statistical analysis on the risks that floods can cause at a flood-prone area and how these can be mitigated. Several studies on flood risk analysis and assessment were conducted to identify possible flood risks in the society (Díez & Garrote, 2020). Approaches including Geographical Information System (GIS) were used to collect and analyze many types of integrated data from flood-prone areas for the identification of flood risks (Al *et al.*, 2020). In Malaysia, a flood-risk map was also used to assess flood damage and vulnerability and the identification of high-risk flooded areas contributed to the mitigation of flooding effects (Romali & Yusop, 2021). However, there is need to design new approaches to increase awareness of flood events through early warnings while taking advantage of the new technological advancements at the same time.

Flood monitoring is one of the key factors which contributes to the mitigation of flood effects by controlling flooding in flood-prone areas. Flood monitoring systems that use the Global System for Mobile Communication (GSM) module to generate Short Message Service (SMS) notifications to respective users were also developed (Wan *et al.*, 2019). Data was collected and sent through SMS notifications as a way of storing data. However, this method proved not to be suitable for live data visualization to support decision-making. Devices interconnection and data exchange were also used to monitor flood through the Internet of Things (IoT) as a network of physical objects. Another developed study used a web-based approach for flood monitoring and early warning (Chamim *et al.*, 2021). The access of warning alarms and monitoring of water levels was via the web that requires internet. This means that communities living in flood-prone areas could be unaware of upcoming floods since only those with internet connectivity could benefit from the system. Some of the existing approaches used Wi-Fi to enable data monitoring from connected devices over the internet (Varma *et al.*, 2019) (Mohd

Sabre *et al.*, 2019). However, wireless network technology is limited to a certain range. To solve this challenge, this project used a mobile network that operates over an unlimited range.

A study conducted at the districts of Uttar Pradesh in India aimed to develop a mechanism that can locate water infrastructure and monitor the deluged areas (Anusha & Bharathi, 2020). The study used the Synthetic Aperture Radar (SAR) technology with images being remotely collected using an antenna attached to a satellite to find the flooded areas. The images taken were analyzed to determine the intensity of flood-affected areas. Similarly, another approach was developed to identify flood-affected regions (Chandrakant *et al.*, 2020). Remotely sensed images were analyzed and classified using Contiguous Deep Convolutional Neural Network (CDCNN). Another study used the image segmentation technique to monitor floods (Muhadi *et al.*, 2020). Images were captured using a surveillance camera fixed close to the river. The identified flood-prone areas gave a point of view on the statistical analysis of affected areas and the effects on society. Nevertheless, community awareness of the imminent flood was not addressed in the aforementioned studies.

The study conducted by Natividad and Mendez developed a system that uses SMS notifications to give daily alerts and updates on flood status to local authorities and other concerned people (Natividad & Mendez, 2018). Kato *et al.* developed a system that remotely monitors the river water level (Kato *et al.*, 2015). Using GSM technology, the people in charge are warned about the upcoming critical condition through an SMS. A similar study was also conducted to develop a flood-detection system using the ThingSpeak platform for data monitoring (Chitra *et al.*, 2020). The system alerts the community near flood-prone areas using SMS notifications. Another study also used SMS notification as an approach to avoid flood destruction (V, 2021). However, many people in rural areas, despite the current technological advancements, do not possess mobile phones. Therefore, the developed alerting methods were not suitable as an early warning for prompt evacuation during flooding.

Furthermore, another developed system (Sekula *et al.*, 2018) uses fiber optic technology to carry information to a central terminal where transmitters and repeaters are required. Another study developed a system that uses remote sensing satellite imagery to collect data from different flood-affected areas. However, the developed systems were not cost-effective, making it hard to implement in certain flood-prone areas. Besides their high-priced designs, the systems were not purposely developed to provide awareness of the possible imminent flood incidents.

Recent studies have revealed that the speed of sound in air changes with changes in ambient atmospheric parameters like temperature and humidity. This can influence the distance measurements of the ultrasonic sensor. Besides, some of the developed flood-detection systems used ultrasonic sensors to detect floods without considering the ambient environmental factors (Binti *et al.*, 2019; Natividad & Mendez, 2018). This can affect the sensed data thus providing inaccurate results in terms of the detected distance.

Although some early-warning operational systems have been deployed at transboundary rivers in some East African Partner States, their development was achieved with the assistance of international donors (EAC Secretariat, 2012), making them inadequate.

To address the various challenges presented by the existing systems, the present study demonstrates the need to develop an IoT-based system for automated floodwater detection and early warning in the East African region. The developed low-cost system can be used in any flood-prone area to detect floods and provide accurate information. The system will continuously monitor information on the flood status and provide updates in real-time, hence, significantly contribute to alleviating the impacts of losses due to floods in the region.

## **CHAPTER THREE**

### **MATERIALS AND METHODS**

#### **3.1 Materials**

##### **3.1.1 Case study**

Tanzania is the greatest country suffered from flood incident in the East Africa region (Erman *et al.*, 2019). Dar es Salaam as one of Tanzania's cities is the rapidest, broadest enlarging municipal area and the riskiest from the flood impacts. In this project, the study was carried out in Dar es Salaam and Arusha as the most cities that have been recently affected by the flood event.

From the study conducted at both Msimbazi river and Jangwani valley, it has been observed that the flood often occurs during a heavy rainfall season. Jangwani is a small area of land located in Dar es Salaam. At this valley, almost every year flood occurs and causes effects on people's lives including both deaths and injuries, property and infrastructure damage (Kwayu, 2019). A total number of 7910 people out of 17 647 neighboring the prone area was predicted to be affected during flood occurrence. The risk to inhabitant near the direction towards the river downstream is increased due to the Msimbazi river which overflows and water flows out to Jangwani valley. The main challenge that often leads to flood occurrence is the underground sand into water and human activities including throwing wastages into river. This causes the blockage of drainage systems and water to flow in inappropriate way.

Despite the fact that, the government restrict inappropriate behaviors done by people living nearby prone area, the problem of removing sand to support freely water flow persists. The figure below shows the Msimbazi river towards the source of the river where the water flows from the upstream to downstream. This is the place where several people live and are likely affected by the flood during a heavy rainfall season.



**Figure 5: Houses submerged into water (John *et al.*, 2019)**

Furthermore, Themis river located in Arusha city is another area affected by flood. During a heavy rain season, water flowing causes Themis river to overflow and affects people's activities including farming, agriculture and house destructions. On handling this problem, people living around this area put sacs full of sand into the water to make it flowing in opposite direction.



**Figure 6: Themis river in Arusha towards downstream direction**

### 3.1.2 Data collection

River has various parameters such as velocity, depth and water flow which can be measured to determine the rise in water level. However, in this study river depth is the only parameter that was taken into account due to the limited timeline. River depth measurement for a certain river and other flood-prone areas gives a point of view on how and at which water level the river can be overflowed. A rigid meter and tape measure were used to measure the river depth.



**Figure 7: Tape measure**



**Figure 8: Msimbazi river depth measurement process**

River depth measurements for both selected rivers were collected. The collected data were used in the distance calculations while comparing the distance detected and the threshold. The regular monitored factor was the increase of the distance between the water surface and the detecting sensor, and the changes in the ambient temperature and humidity. In this case the ultrasonic, DHT22 temperature and humidity sensors were used. The observation done at rivers showed the flood incident occurs very fast at river downstream compared to river upstream. The table below shows the maximum and minimum river depth measurements collected from both Msimbazi and Themis rivers located in Dar es Salaam and Arusha respectively. Due to the fact that the community close to flood-prone area are the most affected, the data collected from the mentioned rivers corresponded to the direction towards the community settlements not the entire river.

**Table 1: River depth measurements**

S/N	River	River depth
1.	Msimbazi river	Maximum river depth: 2 m 20 cm Minimum river depth: 75 cm
2.	Themis river	Maximum river depth: 25 cm Minimum river depth: 37 cm

### 3.1.3 Distance detected calculations

The distance between the water surface and sensor position was the primary parameter to calculate in determining the rise in water level. The minimum and maximum distances that the sensor can detect are 2 cm to 400 cm respectively. The speed of sound in air changes with temperature and humidity. To accurately calculate the detected distance, the ambient temperature and humidity should be considered when calculating the speed of sound. The ultrasonic sensor detects the distance between the sensor and the targeted object (water surface) using the two transducers. The trig transducer emits acoustic sound waves which hit (the transmitter of the sensor) the water surface and reflect towards the echo transducer (the receiver of the sensor). The distance was calculated basing on the speed of sound in air and the time of flight of the sound waves between the sending and receiving transducers. However, only the time taken for the sound waves to travel to the object was considered, thus the time was divided by 2.



The speed of sound in air is 331.4 m/s (at 0 °C of temperature and 0 % of humidity). In this project, the speed of sound in a target environment area was calculated by considering the ambient temperature and humidity. The monitored parameters; distance, temperature, and humidity were measured in cm, °C, and % units respectively. Formulas 1, 2 and 3 show the equation of distance calculated without considering the ambient temperature and humidity, the speed of sound for a targeted area and distance calculated with the ambient temperature and humidity taken into account respectively.

$$D = (T/2) * S \tag{1}$$

Where  $S$ : Speed of sound in the air,  $T$ : Time of flight, and  $D$ : Distance

$$S = 331.4 + (0.606 * T) + (0.0124 * H) \tag{2}$$

Where  $S$ : Speed of sound for a targeted area,  $T$ : Temperature, and  $H$ : Humidity

$$D = (T/2) * S \tag{3}$$

Where  $S$ : Speed of sound for a targeted area,  $T$ : Time of flight, and  $D$ : Distance

### **3.1.4 Stages considered for flood detection and monitoring**

Flood detection event happens when there is a rise in water level and the distance detected between the sensor and the water surface is greater than the required threshold. Three stages namely safe, moderate and danger were considered during the flood monitoring. Each stage states the condition of the detected water level and hence determining if there is occurrence of floodwater. The table below shows the selected stages to be considered.

**Table 2: Water level stages**

S/N	Stages	Description
1.	Safe	This is the stage where there is no rise in water level (no rainfall) thus, there will be total safety of the community close to prone area.
2.	Moderate	This stage presents the rise in water level though it doesn't affect the community. In this case people in charge of flood monitoring should be careful and continuously keep eyes open on the status of the current water level.
3.	Danger	This is the critical condition in which the water level exceeds the required threshold, thus an alert is automatically sent to the concerned people by generating an alarm through the buzzer and by sending an SMS through a mobile phone.

### 3.2 Methods

#### 3.2.1 Software Development Model used

Different software development methodologies can be used to develop a system from the design to implementation processes. The most popular used models are agile and waterfall. By comparing the two models, agile was found more effective for the proposed system. The table below shows the comparison between the agile and waterfall software development models.

**Table 3: Comparison between the agile and waterfall software development models**

S/N	Agile model	Waterfall
1.	Agile is a repetitive software development model that consolidates a continual and collaborative process.	Waterfall is a consecutive software development model that can operate collaboratively but activities are performed in a linear process
2.	With the agile, the progress can be measured within each phase	Waterfall model is easy to understand but the progress can not be measured within each phase
3.	With the agile model, system development and testing process can be performed in parallel and hence hastening the project.	Waterfall delays project as for starting the project all requirements should be well known.

In this project, the agile software development model was used for a continuous iteration of the system development and in the testing process of the viable prototype. An improvement was performed for each complete stage of the system that was found to be needed.

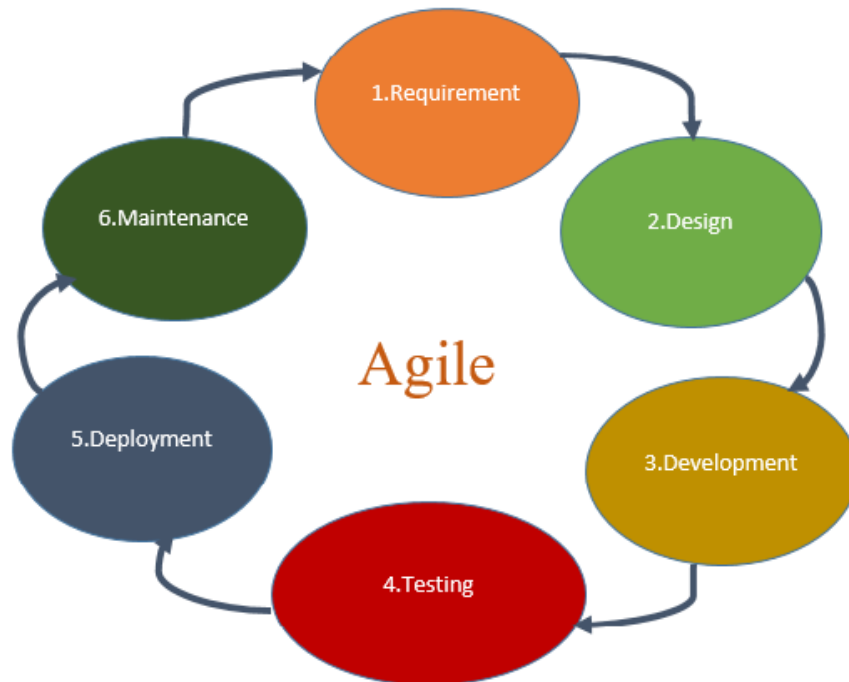

**Figure 9: Agile software development process**

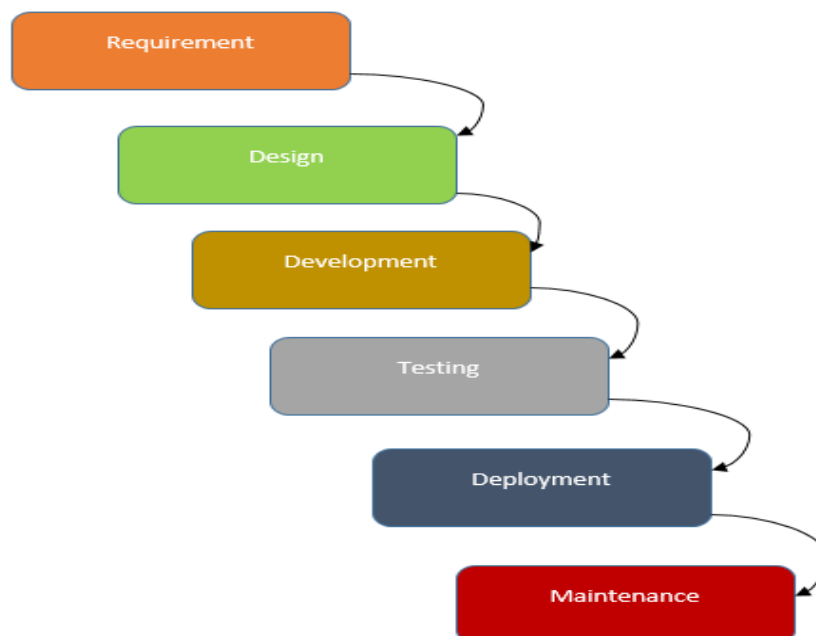

**Figure 10: Waterfall software development model**

### **3.2.2 System design and specification**

The developed system was designed into three units namely the sensing, processing, and alerting units

#### **(i) Sensing unit**

This unit comprises of ultrasonic HC-SR04, temperature and humidity sensors for the determination of distance, environmental temperature and humidity respectively. The ultrasonic sensor is used to detect the distance between the sensor and the object in its proximity. In the present study, the ultrasonic sensor was used to detect the rise in water levels while measuring the distance detected between the water surface and the sensor. The sensor operates at a frequency of 40 Hz and a range of 0.02 to 4 m. The working voltage and current are 5 V and 15 mA respectively. The purpose of using temperature and humidity sensors was to ensure the monitoring of temperature and humidity changes in a given flood-prone area. The DHT22 sensor type was the better selection with a sampling rate of 0.5 Hz every 2 seconds. The sensor has an in-built basic chip that performs analog to digital conversion and outputs a digital signal with the humidity and temperature. The working voltage ranges between 3 - 5 V while a maximum of 2.5 mA was employed in the current conversion. The DHT22 sensor operates at a temperature range of -40 to +125 °C, with an accuracy of  $\pm 0.5$  °C and a humidity range of 0 to 100 %, with an accuracy of  $\pm 2$  to 5 %.

#### **(ii) Processing and monitoring unit**

In this unit, Arduino Uno R3 was used as an open-source microcontroller board. It operates at 5 V and 16 MHz of voltage and clock speed respectively. The microcontroller receives data from sensors for further processing and analysis. The GSM module SIM808 is a hardware device used to establish communication between the cellular network and the mobile phone user. The device operates at a voltage of 3.4 to 4.4 V harvested from an external power supply with an operating temperature of -40 to 85 °C. In this unit, the module was used to provide internet connectivity for real-time data monitoring in the cloud.

#### **(iii) Alerting unit**

The alerting unit consisted of a buzzer and a GSM module. An alarm and SMS notification methods were used to alert the concerned authorities. The buzzer was used to produce an alarm for alerting the community near the flood-prone area. The device operates at a voltage of

4 V–8 V and 2300 Hz of the resonant frequency. With the use of a GSM module, SMS notifications will be sent to local authorities. Furthermore, a Liquid Crystal Display (LCD) which operates at a voltage of 4.7 - 5.3 V with a current consumption of 1 mA was used to display the water level condition. Figure 1 shows the block diagram of the developed system.



**Figure 11: System architecture**

Figure 11 shows the developed system architecture. System architecture is defined as a conceptual model showing how the system will be installed in a particular targeted flood-prone area. The system was covered inside a PVC pipe fixed along the river. Polyvinyl Chloride pipe is made of a plastic with a thickness wall which enables ultrasonic acoustic waves to pass through the wall and hits the water surface which is an object in the sensor's proximity.

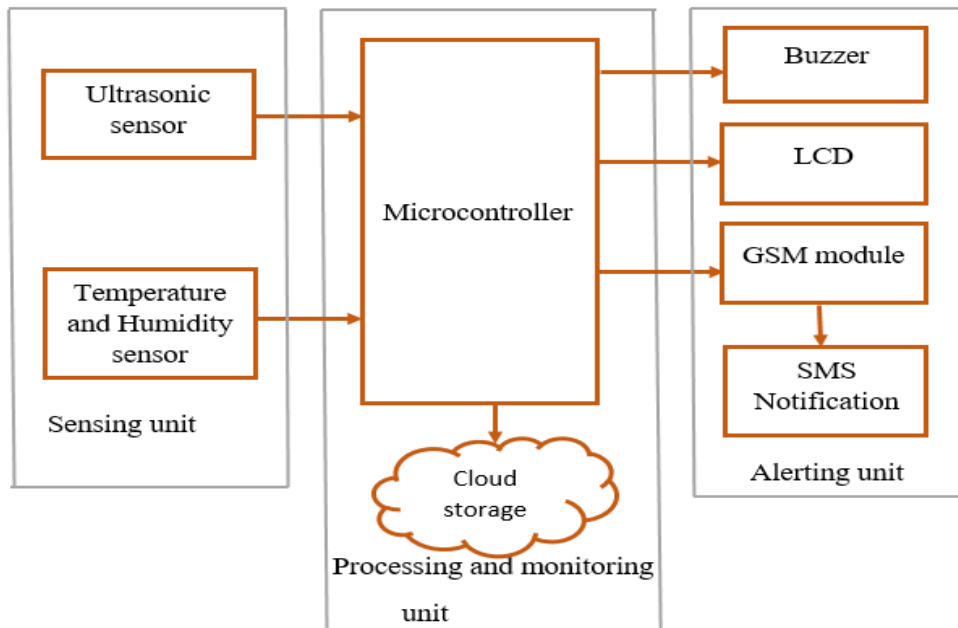

**Figure 12: Block diagram of the developed system**

### 3.2.3 Description of electronics devices used

#### (i) Microcontroller

Arduino Uno R3 is a free open source microcontroller board that is easy to program, delete and reprogram at any instant of time. It operates at 5 V of voltage and 16 MHz of clock speed. The board is designed purposely as an inexpensive way for users to design devices that communicate with their environment using sensors and actuators. With the help of Arduino shield, Arduino can send and receive information over the internet (Louis, 2016) .



**Figure 13: Arduino Uno**

## (ii) Ultrasonic sensor

The ultrasonic sensor HC-SR04 was designed to detect the distance between the sensor and the object in its vicinity (Alselectro, 2013). The sensor module consists of 4 pins as shown in the Fig 8. It consists of ultrasonic transmitter which transmits the sound waves and when the transmitted waves hit an object, the reflected waves called echo waves are bounced back to the ultrasonic receiver. It is also simple to direct and focus the beam of the ultrasonic as diffraction of its small waves due to their short wavelength (Kaur *et al.*, 2015).

The distance is calculated based on the sound's speed (approximately 343 m/s after reflection from an object) and time flight taken for the reflected waves to turn back to the sensor. From the context of the developed prototype, the rise in water level will be monitored using ultrasonic sensor which continuously detects the distance between the water surface and the sensor. The module is connected to the microcontroller which processes and analyzes the sensed data to determine the water level status compared to the required threshold.



**Figure 14: Ultrasonic Sensor HC-SR04**

## (iii) Humidity and Temperature Sensor

The DHT22 Humidity and Temperature is used to monitor and detect the changes of the ambient humidity and temperature in the targeted local area (Bogdan, 2017). The sensor has 3 working pins as shown in the Fig. 9. The basic chip inside the sensor performs the analog to digital conversion and output a digital signal with humidity and temperature. The main purpose of using this sensor in the developed system is to accurately calculate the detected distance. The DHT22 provides a precise value of temperature and humidity, long term stability and high reliability values are also ensured (Srivastava *et al.*, 2018).



**Figure 15: DHT22 Humidity and Temperature Sensor**

**(iv) Wireless MODEM**

The Global System for Mobile Communication (GSM) module is among the class of wireless modem used for communication establishment between the cellular network and mobile phone (Bharavi & Sukesh, 2017). The module requires a SIM card to be inserted into the slot; it can be used to call, send and receive an SMS. In the developed system, a high quality and performance GSM Module SIM808 which has a better signal reception capability was used. The main purpose is to provide an internet connectivity for data transmission to the cloud storage and send the SMS notification to the concerned people about the upcoming flood incident. Based on the functionality of the proposed system, the SMS will be sent to the subscribed mobile phone numbers from a microcontroller through GSM module whenever there is excess of water level over the threshold.





**Figure 16: GSM Module SIM808**

**(v) Warning device**

A buzzer whether active or passive is an electrical device that is used to produce a buzzing sound. The device operates at a voltage from 4 V to 8 V and 2300 Hz of resonant frequency. The buzzer is interfaced with the output pin of microcontroller for generating a signal in case the required water level is exceeded. In this project, a passive piezoelectric buzzer was used for the purpose of notifying the community when the flood incident occurs. This will enable people living closely to the prone areas to fast and early evacuate and save their lives. Furthermore, the concerned authorities will be able to act fast and take possible actions to help the affected people.



**Figure 17: Buzzer**

**(vi) Liquid Crystal Display (LCD)**

The LCD is an electronic display which is used to display the content by using liquid crystal. The display consists of two rows while each row can display only 16 characters. The 16x2 LCD module is interfaced to the pins of microcontroller. In the developed system, a 16x2 LCD module was used to display the current status of the water level.

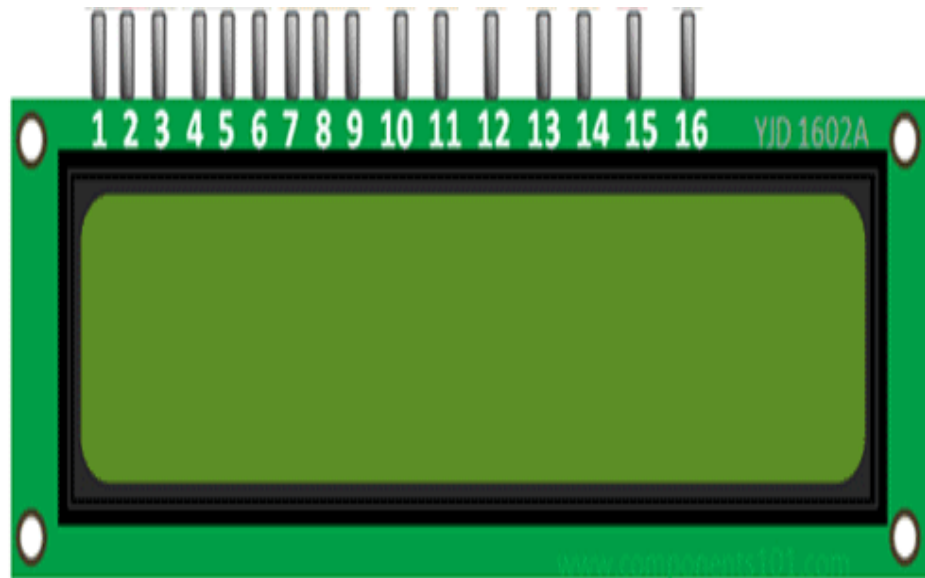

+

**Figure 18: 16x2 LCD module**

### **3.2.4 System implementation**

**(i) Configuration and integration of the system components**

The Fig. 18 and Fig. 19 demonstrate system circuit and schematic diagrams respectively. Circuit diagram is a graphical representation that depicts how system components are electrically connected. It also shows the components flow and relationship in electrical circuit. The components of the system were configured on the Arduino board before their integration. Arduino Uno consists of a single-board microcontroller that reads inputs from various sensors and other devices connected to it and turns them into an output. The board comprises 14 digital input and output pins, and 6 analog pins that use an analog to digital converter. The ultrasonic sensor trig and echo pins were connected to pins 10 and 13 of the Arduino respectively. The trig pin was set as output while the echo pin was set as an input. The DHT22 temperature and humidity sensor data pin was connected to the analog pin A0 of the Arduino. The GSM module transmitter (Tx) and receiver (Rx) pins were connected to pins 2 and 3 of the Arduino

respectively. The supply wire of the buzzer was connected to pin 9 of the Arduino and set to output. Light Emitting Diode (LED) long leg pin was connected to pin 8 of the Arduino and set to output. Pins (RS, E, D4, D5, D6, and D7) of LCD were set up on the Arduino digital pins 12, 11, 7, 6, 5, 4 respectively. Leaving out the GSM module, other components were supplied with an energy of 5 V from the Arduino.

During the system integration process, all units were linked together. Their interaction proved the effective system functionality and its compliance with the requirements.

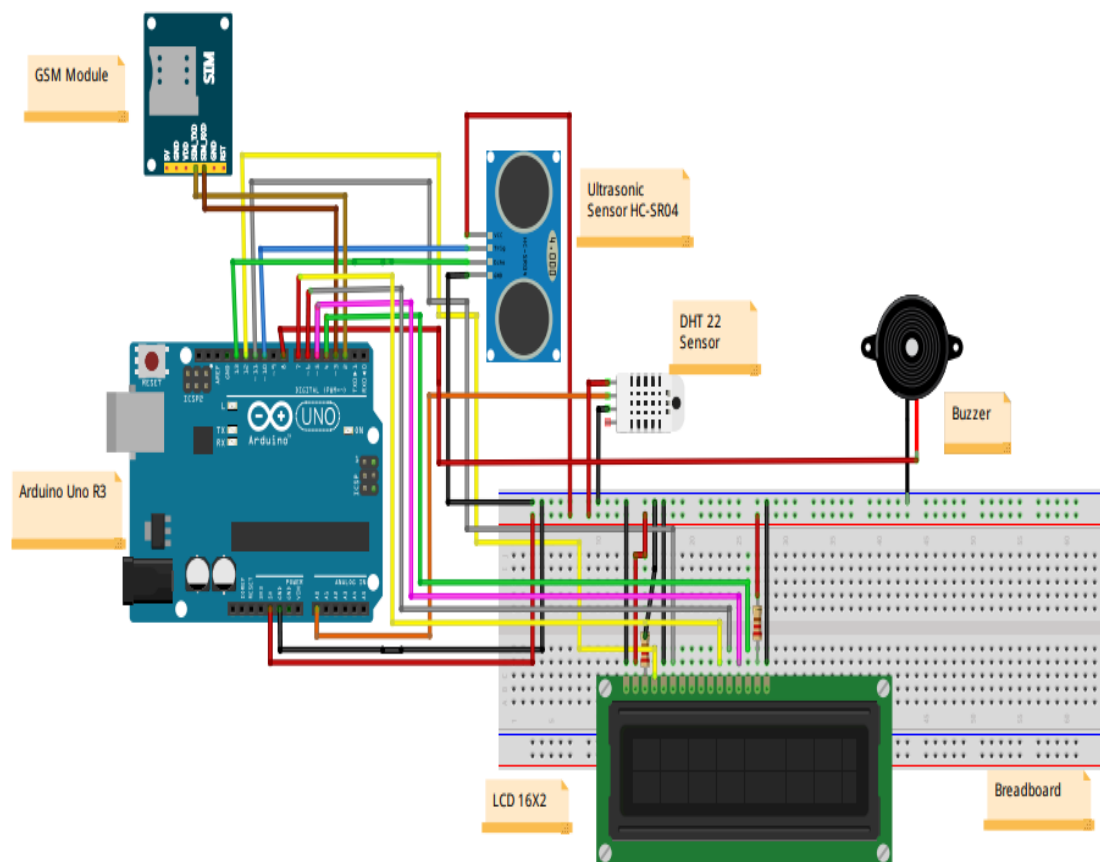

**Figure 19: Circuit diagram of the developed system**

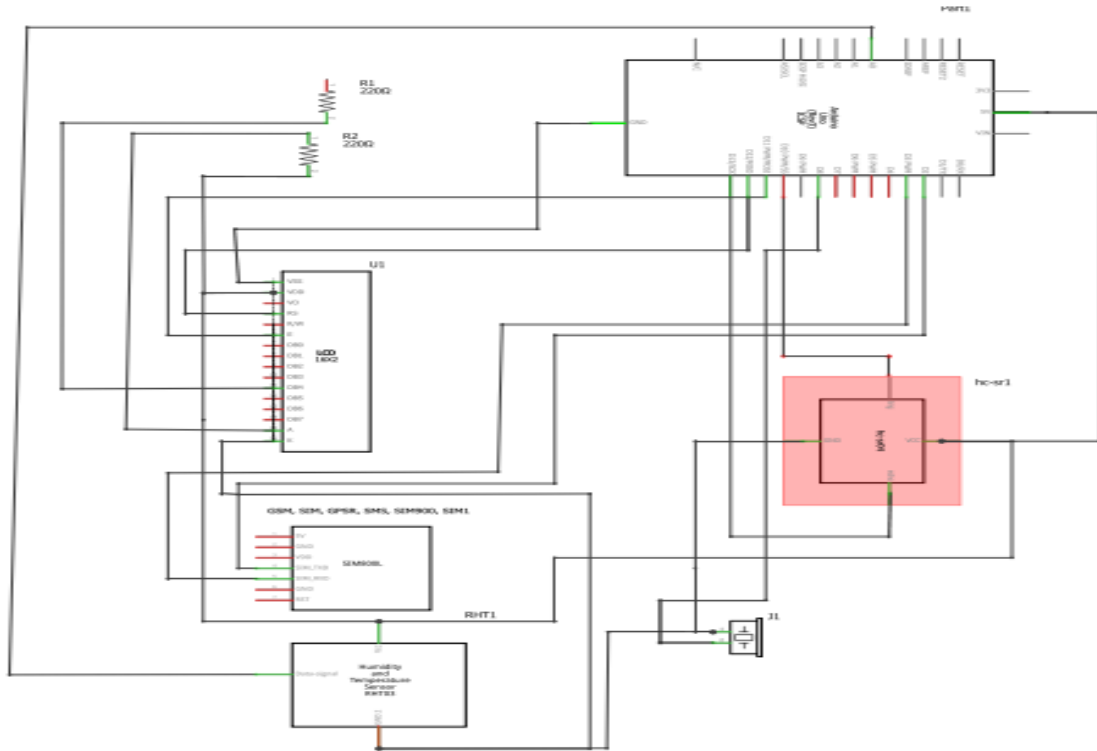

**Figure 20: Schematic diagram of the developed system**

**(ii) Programming languages and software used**

With the help of the Arduino Integrated Development Environment (IDE), the system was developed using the C programming language, a general-purpose, procedural, and high-level computer programming language. Arduino IDE is an open-source software tool that consists of a text editor written in functions from C++ and C programming languages. The software provides access for users to create their modules and use them in the program. The text editor from Arduino IDE was used to write the program code. The libraries needed for sensors and other components were imported. The program output was seen on a serial monitor window in Arduino IDE.

The ThingSpeak platform was used to continuously monitor the collected data from the sensors. ThingSpeak is an IoT open source and analytics platform designed for aggregation, analysis, and visualization of data live streams in the cloud. The platform plays a key role in the storage and retrieval of data from the sensing unit over the internet using the Hypertext Transfer Protocol.



**Figure 21: ThingSpeak IoT Cloud Website**

**(iii) Functionality of the developed system**

The Fig. 22 shows the flowchart diagram of the developed system. The flowchart is defined as a pictorial diagram representation of an algorithm used to represent information process for both system activity and connectivity (Prasad, 2014). The activities and the connection order are shown by boxes of different kind and rows respectively. The flowchart diagram on Fig. 22 shows a step by step system operation from the start to the end.

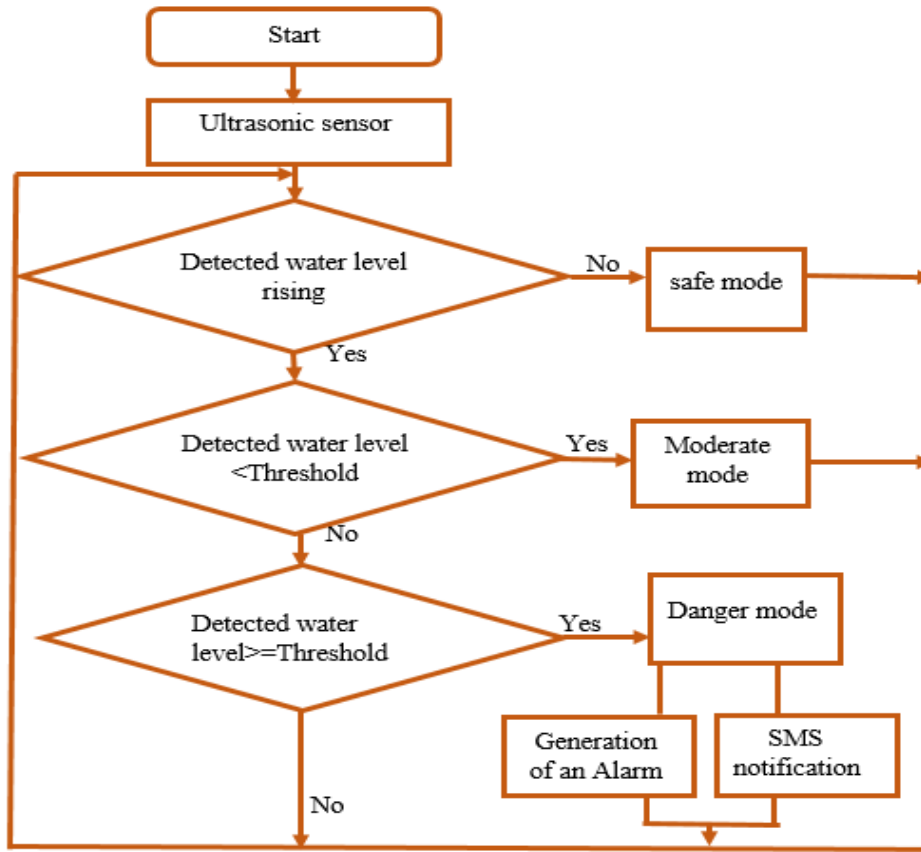

**Figure 22: Flowchart of the developed system**

The system was powered on and continued to run iteratively for the sensors and other components to operate and start the initialization of parameters. In this project, the ultrasonic sensor was used to detect the distance between the water surface and the sensor position. The sensor continuously monitored the rise in water level while measuring the detected distance. The temperature and humidity sensors monitored the changes in the ambient temperature and humidity respectively. The data collected from the sensors was forwarded to the microcontroller to be processed and analyzed. After data analysis, each single output data was compared to the required threshold. A rise in the water level greater than the threshold signified the reduction of the distance between the water surface and the sensor. In this case, the community was alerted through an alarm generated by the buzzer and an SMS notification sent to the local authorities. Furthermore, the data were continuously monitored in the cloud storage through the ThingSpeak platform.

### 3.2.5 System testing

System testing is a process that is applied on a complete integrated system. Before testing the entire system, a prior unit and integration testing activities for all component and their

functionality were performed. To test and evaluate the developed system's conformity with the requirement, two approaches namely lab and field-testing were conducted.

**(i) Lab-testing approach**

During the lab testing, two water containers were used. Water from the second container was flowing into the first container through an attached faucet. The ultrasonic sensor was mounted on the first container to continuously detect the rise in water level.

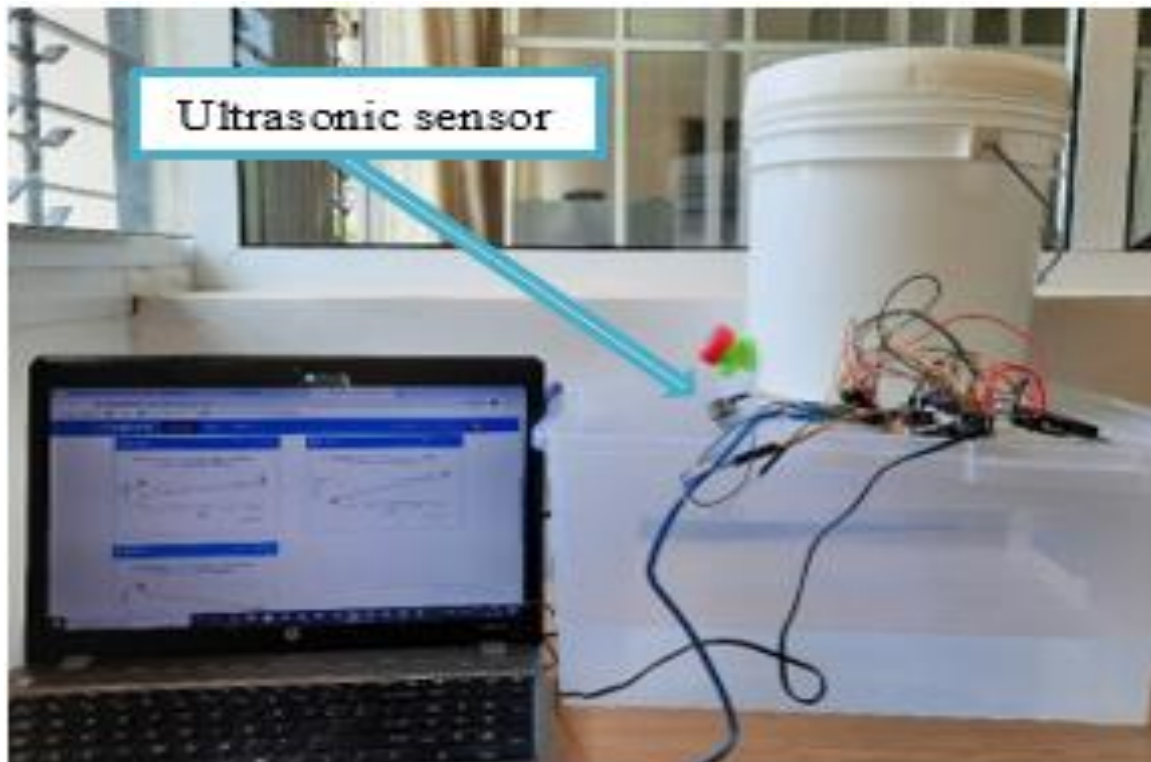

**Figure 23: Connection of hardware components used in lab testing approach**

**(ii) Field-testing Approach**

The field-testing approach was conducted using a prototype from an assembled circuit built on a designed Printed Circuit Board (PCB). Figure 24 shows the various steps in the prototype preparation process starting from the placement of the system parts on PCB. After soldering, a complete prototype was provided.

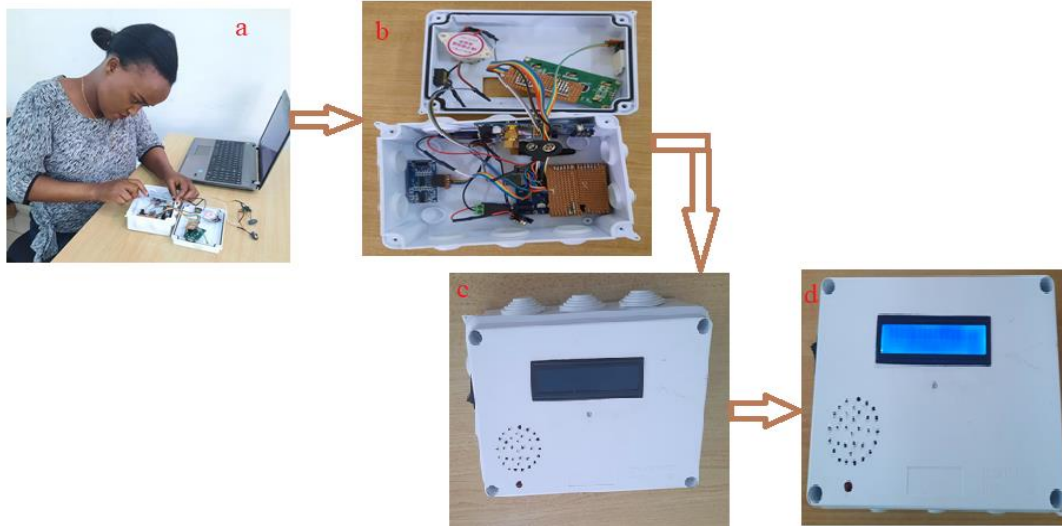

**Figure 24: Prototype development**

The purpose of the field-testing process was to ensure that the system could effectively be deployed to a certain flood-prone area and operate as expected. The system was installed at Themis river as one of the case studies at a maximum river depth of 37 cm. The ultrasonic sensor was positioned facing the water surface to continuously monitor the rise in water level. The temperature and humidity sensors were unceasingly monitoring the changes in the ambient temperature and humidity respectively.



**Figure 25: System installed at the field**



During the study carried out in the selected rivers, the observation showed that human activities including wastage and sac full of sand into the river can contribute to flood occurrence. This may also affect the system flexibility in the context of installation and responsiveness. A successful system implementation would require all these challenges to be addressed. In this case, an involvement of various stakeholders is a paramount important for the future use of the system.

## CHAPTER FOUR

### RESULTS AND DISCUSSIONS

#### 4.1 Results

The results presented in this chapter show the outputs obtained during both lab and field-testing approaches.

##### 4.1.1 Lab-testing approach results

Based on the water level in the first container, the initial distance measured between the sensor and the water surface was 10 cm. The ultrasonic sensor continuously monitored the rise in water level. As the water from the second container flowed into the first one, an increase in water level was detected. The distance measured between the water surface and sensor was less than 5 cm, indicating a danger condition. In that case, an alarm was produced reaching a frequency of approximately 2300 Hz. An SMS notification was also sent to a subscribed mobile phone number. The alarm and SMS notification were triggered when the water level was in a danger condition. Besides, LED was switched on to indicate the danger condition of the distance detected. The sensed distance, temperature, and humidity data were updated after every 15 seconds both in cloud storage and on the serial monitor. It was also observed that an increase in water level in the container led to the reduction of the distance between the water surface and the sensor, and vice-versa. Table 4 shows three comparison statements used to control the rise in water level. The comparison was done for the detected distance between the current water surface, sensor and threshold.

**Table 4: Comparison statements used for lab testing approach**

S/ N	Water level measurement	Mode Description
1.	The detected distance between sensor and water surface in a container $\geq 10$ cm	Safe mode: no rise in water level has been detected.
2.	The detected distance between sensor and water surface in a container $< 10$ cm and the detected distance between the sensor and water surface in a container = 5 cm	Moderate mode: there is a rise in water level but the condition can be maintained.
3.	The detected distance between the sensor and water surface in a container $< 5$ cm	Danger mode: there is a rise in water level with a high probability of flood occurrence.

**Table 5: Initial numerical outputs and corresponding water level indication status from serial monitor window during Lab testing approach conditions**

S/N	Distance (Cm)	Temperature (°C)	Humidity (%)	Water level indication status	Message sent
1.	10	24.90	83.10	Safe mode	None
2.	5	24.90	83.00	Moderate mode	None
3.	2	24.90	83.80	Danger mode	Warning!! Critical conditions

The results obtained from the lab testing approach were effectively evaluated and met the requirements. As presented in Fig. 26, Fig. 27 and Fig. 28, an instant visualization of the live data was enabled for the detected distance, temperature, and humidity data. Figure 29 shows an SMS notification sent to the local authorities when the water level was in danger mode

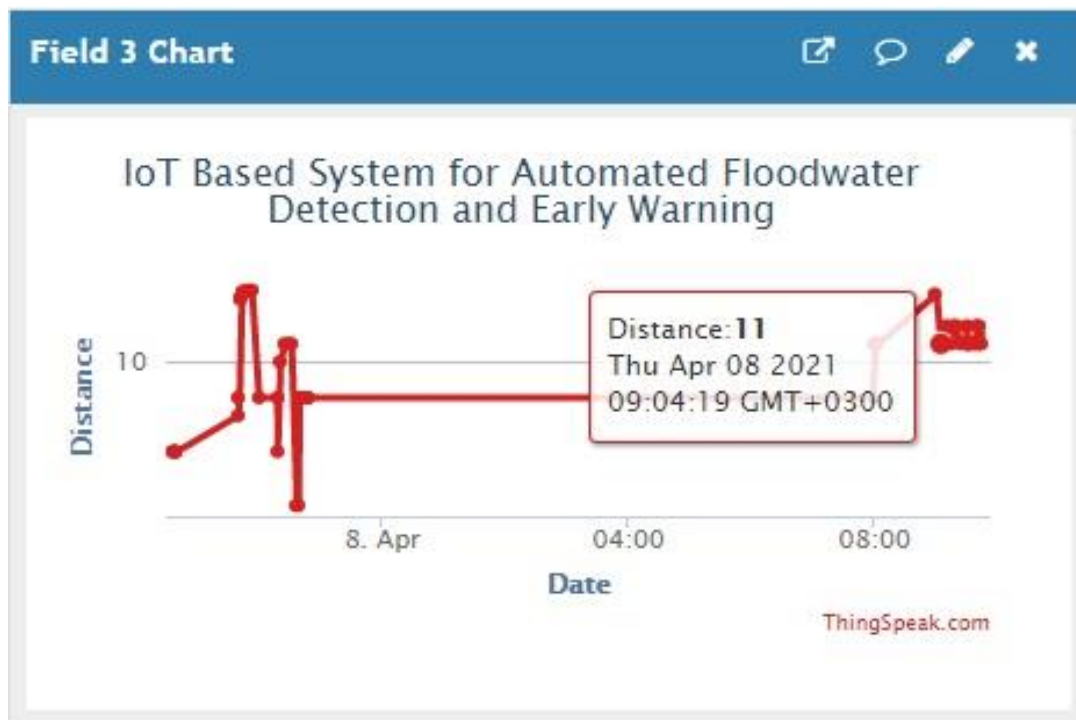

**Figure 26: Visualization of data from the ultrasonic sensor**

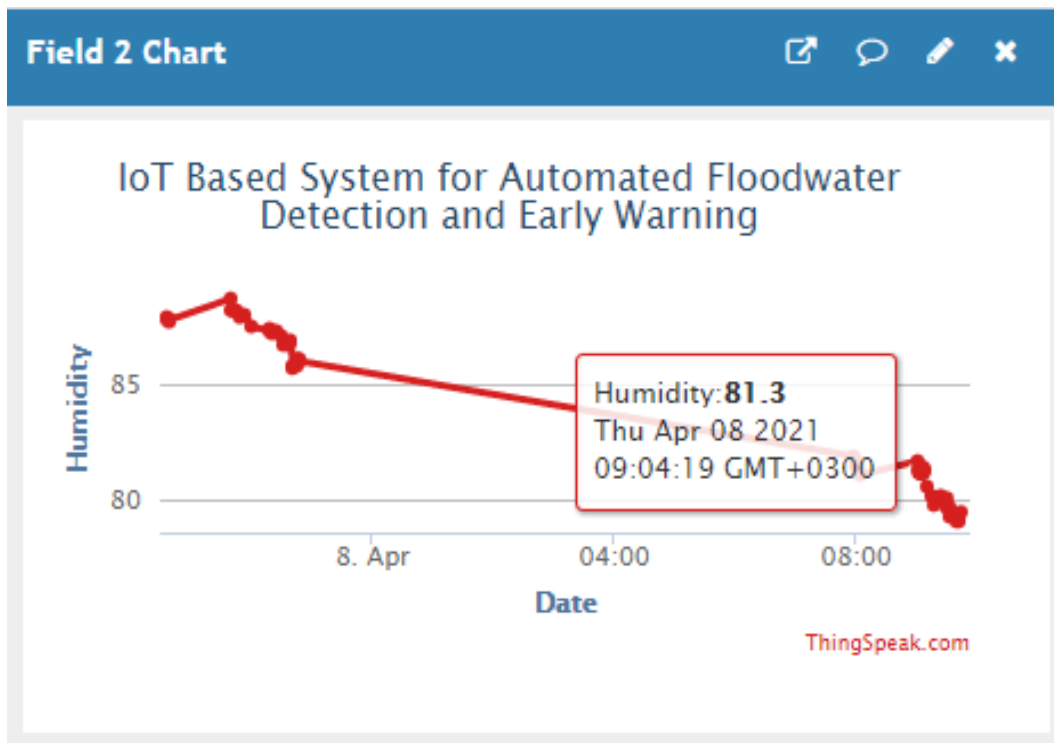

Figure 27: Visualization of humidity data from the DHT22 sensor

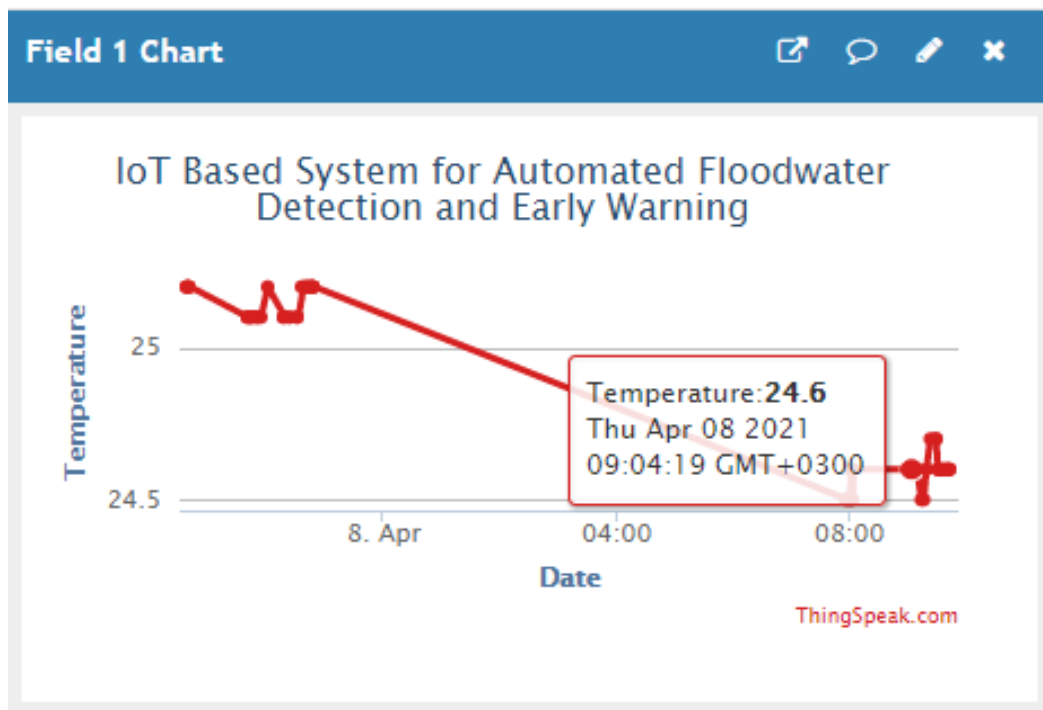
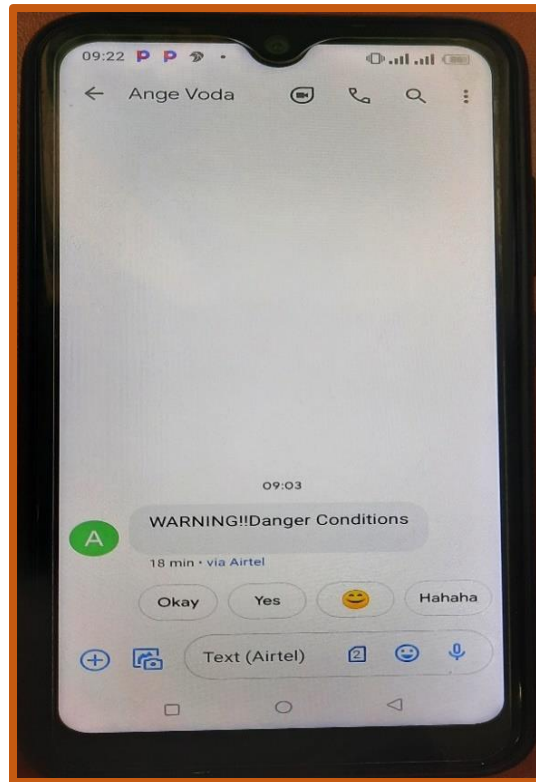
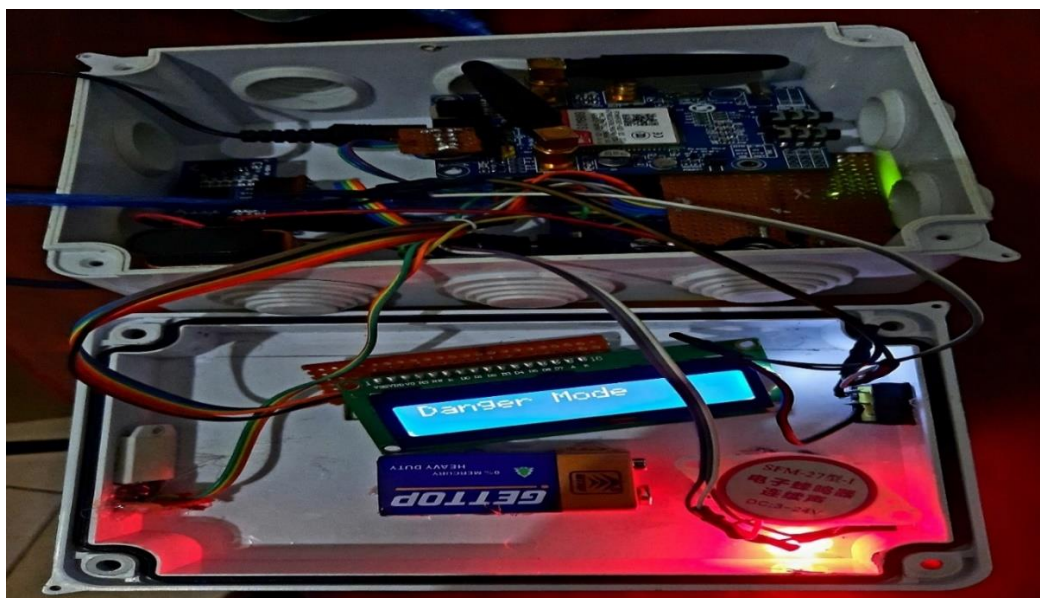

Figure 28: Visualization of temperature data from the DHT22 sensor



**Figure 29: SMS notification**

Liquid Crystal Display (LCD) was used as water level status indicator to display the water level conditions. The Fig. 30 shows the danger mode indicated while the distance detected was less than the required threshold.



**Figure 30: water level status indicator**

### 4.1.2 Field-testing approach results

During the field-testing process, the system was installed at a maximum river depth of 37 cm. From the system evaluation process, it was observed that the rise in water level which can cause a flood incident occurred when there was heavy rainfall. As the water flowed into the river, a certain change in the water level was detected. However, this did not indicate any negative effects because the distance detected between the sensor and the water surface was much less than the required threshold. Data from the sensors were continuously sent to the cloud and monitored in real-time. Furthermore, the water level condition was displayed using the Liquid Crystal Display (LCD) device. Figure 31 shows the water level conditions in the field.



**Figure 31: Display of the water level condition**

The Fig. 32, Fig. 33 and Fig. 34 show visualizations of live data sent in ThingSpeak platform. The distance detected shows that there was an increase in water level due to the heavy rainfall occurred a day prior to the testing process.

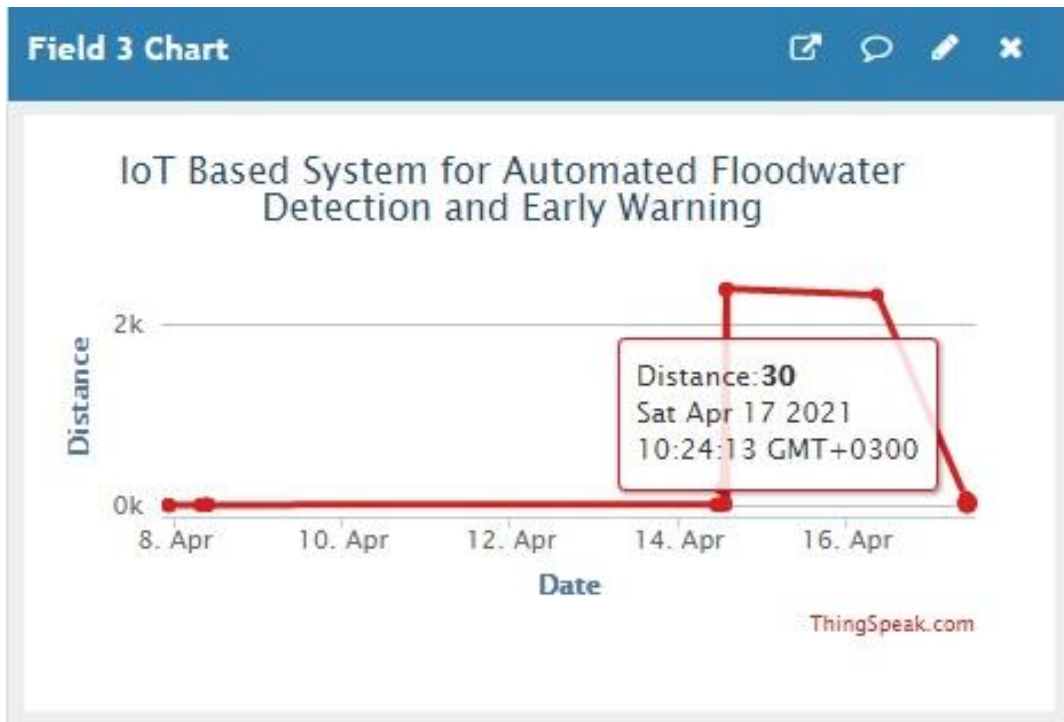

Figure 32: Visualization of data from the ultrasonic sensor

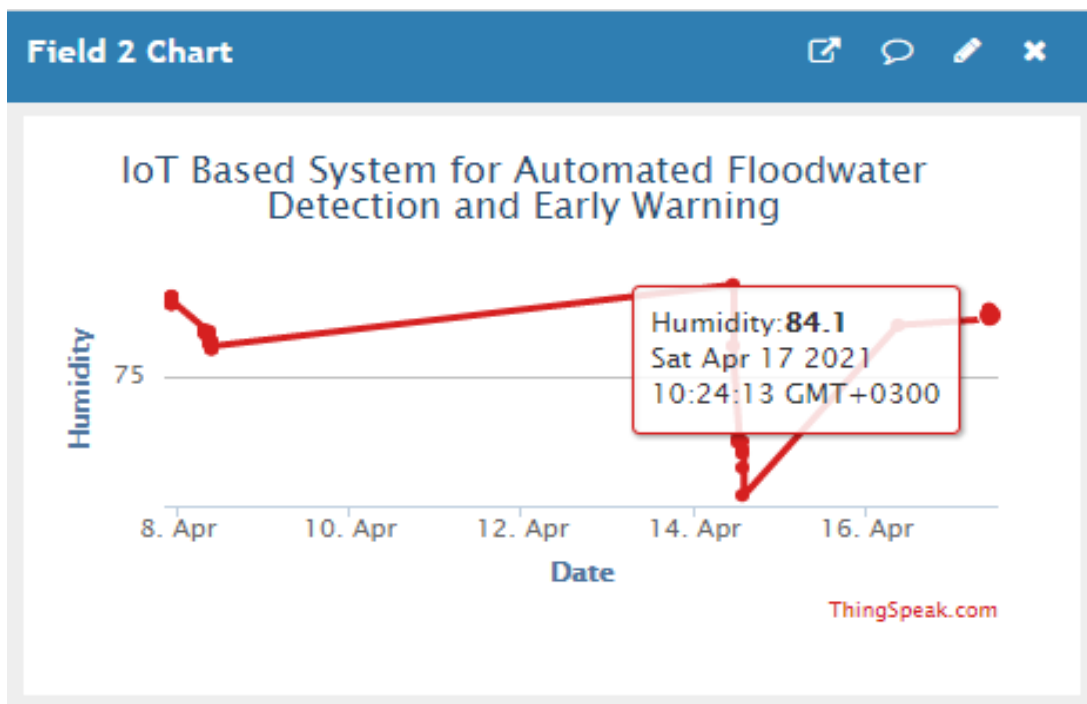
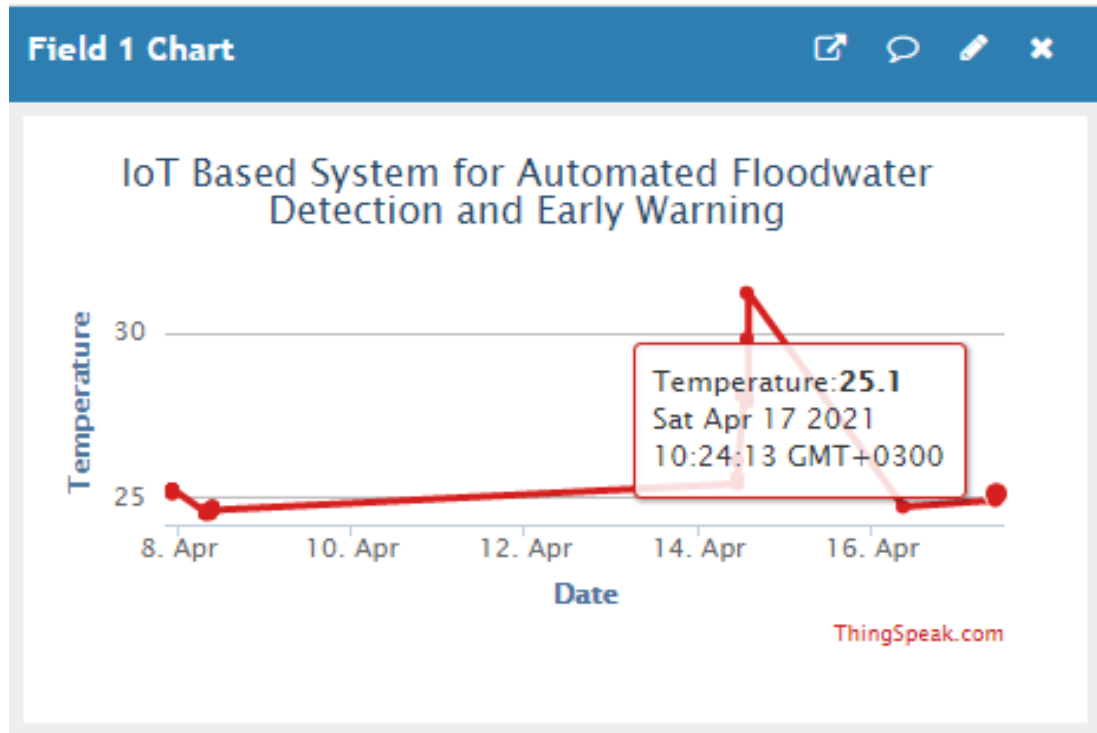

Figure 33: Visualization of humidity data from the DHT22 sensor



**Figure 34: Visualization of temperature data from the DHT22 sensor**

#### 4.1.3 Attributes of the developed system

Flood event can occur in places with and without water bodies and leaves a high rate of negative impacts on the community neighboring the prone area. Table 6 shows the proved features of the developed system.

**Table 6: Developed system attributes**

S/N	Attributes	Description
1.	Low-cost	The developed system is cost-effective and can be deployed at any flood prone area.
2.	Real time updates and flood detection	The updates on flood occurrence status were timely provided.
3.	Fast alert method	Alerting the community and local authorities is very fast, people are informed about the imminent flood incident very early before it affects them.



## 4.2 Discussions

The experiments conducted in the lab and the field proved that floods can be automatically detected and their effects on the community reduced. Figure 22 shows the instant flood-detection process from the lab approach. The distance, temperature, and humidity parameters were monitored using ultrasonic, and temperature and humidity sensors respectively. Updates of data from the sensors were provided every 15 minutes in the cloud. Figure 25, Fig. 26, and Fig. 27 represents the visualization of the live-stream data of distance, temperature, and humidity. The rise in water level which exceeds the required threshold leads to the generation of an alert. Figure 28 shows the text message that was sent to the local authorities to inform them of a danger condition. In such a case, rescue can be provided to the flood victims without delay. The alarm alert method generated by the buzzer proved to be a fast way to alert the community of danger. Thus, the vulnerable can be alerted early and evacuated to save their lives.

The testing process in the field proved that the system can effectively be installed in a particularly flood-prone area. Figure 24 shows the developed prototype installed at Themis river. Based on the observations, results, and evaluations carried out during the project implementation, the system's affordability, accuracy, efficiency, and effectiveness are assured.

## CHAPTER FIVE

### CONCLUSION AND RECOMMENDATIONS

#### 5.1 Conclusion

Flood incidents are very hard to manage during heavy rainfalls and affect people living close to flood-prone areas. This study aims to contribute to disaster risk reduction by alleviating the effects of floods on society. This can be achieved by detecting floods and alerting the community in flood-prone areas. The developed system proved that the information on flood status can be provided within 15 seconds. The results from the system's functionality showed that the effects of flood incidents can be mitigated through an early-warning system that is user-friendly and does not require complex maintenance. From the gaps presented in the existing systems, the followings were addressed in this project:

- (i) The developed system could quickly detect the rise in water level and continuously sent real-time updates to the cloud.
- (ii) The equipment used for system development was quite affordable as compared to those used in the already existing systems.
- (iii) The community awareness of imminent flood incidents was increased by providing alerts through an alarm as the fastest way.

#### 5.2 Recommendations

The use of the developed system will effectively improve the current method used in flood detection and monitoring in the region. The recommendations to the concerned stakeholders in climate change and disaster risk reduction sectors are as follow:

- (i) To use the developed system and adopt to assist in promoting early warning systems as one of the current EAC existing programs.
- (ii) Through the Ministry of land, Housing and Human Settlement development, the local authorities should assist and encourage the community on proper land use, drainage systems and other settlements nearby water bodies
- (iii) The involvement of meteorological agencies within the region is required to evaluate the operation of the developed system for its successful implementation.

Flood incidents can occur in different water bodies and other flood-prone areas. Thus, a deep understanding of flood management is required. The following directions should be taken into consideration for future work:

- (i) Various river parameters can be measured to determine rising in water level, however in this work only river depth has been taken into account. Therefore, considering other parameters such as velocity and water flow in detecting the rise in water level will add a value to this work.
- (ii) Prototyping and testing processes were conducted using the energy harvested from an external battery, however the solar power was the initial suggestion to sustain the effective system operation. Therefore, the improvement of system powering method will be an added advantage.

## REFERENCES

- Al, A., Muktarun, B., & Supria, I. (2020). Flood Hazard , Vulnerability and Risk Assessment for Different Land Use Classes Using a Flow Model. *Earth Systems and Environment*, 4(1), 225–244. <https://doi.org/10.1007/s41748-019-00141>
- Alselectro. (2013). *Arduino–UltraSonic Sensor for Distance Measurement*. <https://www.wordpress.com/2013/03/08/arduino-ultrasonic-sensor-for-distance-measurement>
- Anusha, N., & Bharathi, B. (2020). Flood detection and flood mapping using multi-temporal synthetic aperture radar and optical data. *Egyptian Journal of Remote Sensing and Space Science*, 23(2), 207–219. <https://doi.org/10.1016/j.ejrs.2019.01.001>
- Armah, A., Yawson, O., Yengoh, T., Odoi, O., & Afrifa, A. (2010). Impact of floods on livelihoods and vulnerability of natural resource dependent communities in Northern Ghana. *Water (Switzerland)*, 2(2), 120–139. <https://doi.org/10.3390/w2020120>
- Banuri, T. (2009). Climate change and sustainable development. *Natural Resources Forum*, 33(4), 257–258. <https://doi.org/10.1111/j.1477-8947.2009.01270.x>
- Bharavi, U., & Sukesh, M. (2017). *Design and development of GSM and GPS tracking module. RTEICT 2017 - 2nd IEEE International Conference on Recent Trends in Electronics, Information and Communication Technology, Proceedings, 2018-January*, 283–288. <https://doi.org/10.1109/RTEICT.2017.8256602>
- Binti, S., Ehkan, P., Sabapathy, T., Jusoh, M., Osman, M., Najib, M., Abdul, Y., Hambali, N., Ali, N., Bakhit, S., Husin, F., Kamil, M., & Jamaludin, R. (2019). *Smart IoT Flood Monitoring System. Journal of Physics: Conference Series*, 1339(1). <https://doi.org/10.1088/1742-6596/1339/1/012043>
- Bogdan, M. (2017). How to Use the DHT22 Sensor for Measuring Temperature and Humidity with the Arduino Board. *Universitatis Cibiniensis*, 68(1), 22–25. <https://doi.org/10.1515/aucts-2016-0005>

- Brémond, P., & Grelot, F. (2013). Review Article: Economic evaluation of flood damage to agriculture - Review and analysis of existing methods. *Natural Hazards and Earth System Sciences*, 13(10), 2493–2512. <https://doi.org/10.5194/nhess-13-2493-2013>
- Brown, V. (2020). *Flooding in East Africa. 1–20*. [https://reliefweb.int/sites/reliefweb.int/files/resources/CFF\\_Report\\_Design - Dar es Salaam-final 2020 - singles\\_compressed.pdf](https://reliefweb.int/sites/reliefweb.int/files/resources/CFF_Report_Design_-_Dar_es_Salaam-final_2020_-_singles_compressed.pdf)
- Catherine, B. (2020). *Flooding hits six million people in East Africa*. <https://www.bbc.com/news/world-africa-54433904>
- Chamim, N., Hardyanto, C., & Putra, T. (2021). Web-Based Flood Hazard Monitoring. *Journal of Robotics and Control*, 2(5), 373–379. <https://doi.org/10.18196/jrc.25110>
- Chandrakant, A., Kakade, V., & Jadhav, J. (2020). Automatic Detection of Flood Using Remote Sensing Images. *Journal of Information Technology and Digital World*, 2(1), 11–26. <https://doi.org/10.36548/jitdw.2020.1.002>
- Chitra, M., Sadhihsukumar, D., Aravindh, R., Murali, M., & Vaithilingame, R. (2020). IoT based Water Flood Detection and Early Warning System. *International Journal of Scientific Research in Computer Science and Engineering*, 8(5), 47–53.
- CRED/EM-DAT/UNISDR. (2018). *Economic Losses, Poverty & Disasters*. Centre for Research on the Epidemiology of Disasters,4,33. [https://www.preventionweb.net/files/61119\\_cred\\_economiclosses.pdf](https://www.preventionweb.net/files/61119_cred_economiclosses.pdf)
- Díez, A., & Garrote, J. (2020). Flood risk assessments: Applications and uncertainties. *Water (Switzerland)*, 12(8), 1–11. <https://doi.org/10.3390/W12082096>
- Hung, N., Minh, V., Tran, S., Tan, V., & Trinh, V. (2016). *An early flood detection system using mobile networks*. *International Conference on Advanced Technologies for Communications*. <https://doi.org/10.1109/ATC.2015.7388400>
- Weiwei, D., Fitzgerald, J., Clark, M., & Hou, Y. (2010). Health impacts of floods. *Prehospital and Disaster Medicine*, 25(3), 265–272. [https://doi.org/10.1017/S104902X\\_00008141](https://doi.org/10.1017/S104902X_00008141)

- EAC Secretariat. (2012). *East African Community Disaster Risk Reduction and Management Strategy*. EAC Secretariat, Arusha, Tanzania. [https://www.ifrc.org/Global/Publications/IDRL/regional/EAC\\_DRRMS\(2012-2016\).pdf](https://www.ifrc.org/Global/Publications/IDRL/regional/EAC_DRRMS(2012-2016).pdf)
- Erman, A., Tariverdi, M., Obolensky, M., Chen, X., Vincent, C., Malgioglio, S., Rentschler, J., Hallegatte, S., & Yoshida, N. (2019). *Wading Out the Storm: The Role of Poverty in Exposure, Vulnerability and Resilience to Floods in Dar Es Salaam*. In *Wading Out the Storm: The Role of Poverty in Exposure, Vulnerability and Resilience to Floods in Dar Es Salaam*. <https://doi.org/10.1596/1813-9450-8976>
- Geography, C. (2016). *Eastern Africa Region*. *Encyclopedia Britannica*, 7, 1–47. <https://reliefweb.int/report/south-sudan/eastern-africa-region-regional-flood-snapshot-november-2019>
- Indrasari, W., Iswanto, H., & Andayani, M. (2018). *Early Warning System of Flood Disaster Based on Ultrasonic Sensors and Wireless Technology*. *IOP Conference Series: Materials Science and Engineering*, 335(1). <https://doi.org/10.1088/1757-899X/335/1/012005>
- John, R., Magina, B., & Kemwita, F. (2019). From Msimbazi River Valley to Mabwepande Settlement: The Resettlement Process and Its Challenges. *Current Urban Studies*, 07(3), 399–426. <https://doi.org/10.4236/cus.2019.73020>
- Kalkan, K., & Akar, İ. (2010). *Effects of Human Activities on Flood Risk and Recommendations for Prevention by Help of GIS and Remote Sensing*. *TIEMS 7th Workshop*. [http://kaankalkan.com/pub/humanactivities\\_flood\\_kaankalkan.pdf](http://kaankalkan.com/pub/humanactivities_flood_kaankalkan.pdf)
- Kato, A., Sindi, R., & Kajjage, S. (2015). Design of an Automated River Water Level Monitoring System by using Global System for Mobile Communications. *International Journal of Computer Science and System Analysis*, 13(11), 106–111.
- Kaur, J., & Tech Student, M. (2015). Distance Measurement of Object by Ultrasonic Sensor HC-SR04. *International Journal for Scientific Research & Development*, 3 (05), 2321–0613. [www.ijrsrd.com](http://www.ijrsrd.com)
- Kwayu, M. (2019). Examining the Nature of a Floodplain Using GIS Open Data: A Case Study of Jangwani Floodplain Terrain in Dar Es Salaam, Tanzania. *Journal of Geography and Earth Sciences*, 7(2), 15–25. <https://doi.org/10.15640/jges.v7n2a2>

- Louis, L. (2016). Working Principle of Arduino and Using it as a Tool for Study and Research *International Journal of Control, Automation, Communication and Systems*, 1(2), 21–29. <https://doi.org/10.5121/ijcacs.2016.1203>
- Maddox, I. (2014). *Three Common Types of Flood Explained*. Intermap Technologies. <https://www.intermap.com/risks-of-hazard-blog/three-common-types-of-flood-explained>
- Mata, H., Alvino, A., Pinheiro, A., & Almeida, A. (2013). Impacts of natural disasters on environmental and socio-economic systems: What makes the difference? *Ambiente e Sociedade*, 16(3), 45–64. <https://doi.org/10.1590/S1414-753X2013000300004>
- Messages, Y., & Progress, S. (2020). *Intense rainfall in mid- and late April causes widespread floods in East Africa and Yemen*. [https://reliefweb.int/sites/reliefweb.int/files/resources/EA\\_Seasonal\\_Monitor\\_2020\\_05\\_04\\_final\\_1.pdf](https://reliefweb.int/sites/reliefweb.int/files/resources/EA_Seasonal_Monitor_2020_05_04_final_1.pdf)
- Mohamed, S., Ebenehi, Y., Adaji, A., Seow, W., Chan, W., Goh, C., & AbdRahim, I. (2017). *Impacts of flood on children and adults' health and ways to sustainable development*. *IOP Conference Series: Materials Science and Engineering*, 271(1). <https://doi.org/10.1088/1757-899X/271/1/012025>
- Mohd, S., Abdullah, S., & Faruq, A. (2019). Flood Warning and Monitoring System Utilizing Internet of Things Technology. *Kinetik: Game Technology, Information System, Computer Network, Computing, Electronics and Control*, 4(4), 287–296. <https://doi.org/10.22219/kinetik.v4i4.898>
- Muhadi, A., Abdullah, F., Bejo, K., Mahadi, R., & Mijic, A. (2020). Image segmentation methods for flood monitoring system. *Water (Switzerland)*, 12(6), 1–10. <https://doi.org/10.3390/w12061825>
- NASA. (2020). *Central and East Africa Floods 2020*. *Disasters Program*. <https://disasters.nasa.gov/central-and-east-africa-floods-2020>

- Natividad, G., & Mendez, M. (2018). *Flood Monitoring and Early Warning System Using Ultrasonic Sensor. IOP Conference Series: Materials Science and Engineering*, 325(1). <https://doi.org/10.1088/1757-899X/325/1/012020>
- Prasad, S. (2014). A Flowchart Based Methodology for Process Improvement. *Quality Concepts '93 World Class Manufacturing Proceedings, October 1993*, 53–74. <https://doi.org/10.13140/RG.2.1.2559.4327>
- Ptz, M. (2020). *Emergency Plan of Action* <https://reliefweb.int/report/united-republic-tanzania>
- Romali, S., & Yusop, Z. (2021). Flood damage and risk assessment for urban area in Malaysia. *Hydrology Research*, 52(1), 142–159. <https://doi.org/10.2166/NH.2020.121>
- Rosenzweig, R., McPhillips, L., Chang, H., Cheng, C., Welty, C., Matsler, M., Iwaniec, D., & Davidson, I. (2018). Pluvial flood risk and opportunities for resilience. *Wiley Interdisciplinary Reviews: Water*, 5(6). <https://doi.org/10.1002/wat2.1302>
- Samuels, A. (2013). Flooding. *Journal of Planning and Environment Law*, 7, 808–809. <https://doi.org/10.5040/9781501397585.0009>
- Sekuła, K., Połec, M., & Borecka, A. (2018). *Innovative solutions in monitoring systems in flood protection. Web of Conferences*, 30(1). <https://doi.org/10.1051/e3sconf/20183001005>
- Sholihah, Q., Kuncoro, W., Wahyuni, S., Puni, S., & Dwi, .E. (2020). *The analysis of the causes of flood disasters and their impacts in the perspective of environmental law. IOP Conference Series: Earth and Environmental Science*, 437(1). <https://doi.org/10.1088/1755-1315/437/1/012056>
- Smiley, L., & Hambati, H. (2019). Impacts of flooding on drinking water access in dar es salaam, tanzania: Implications for the sustainable development goals. *Journal of Water Sanitation and Hygiene for Development*, 9(2), 392–396. <https://doi.org/10.2166/washdev.2019.168>



- Srivastava, D., Kesarwani, A., & Dubey, S. (2018). Measurement of Temperature and Humidity by using Arduino Tool and DHT11. *International Research Journal of Engineering and Technology*, 05(12), 876–878.
- Svetlana, D., Radovan, D., & Ján, D. (2015). The Economic Impact of Floods and their Importance in Different Regions of the World with Emphasis on Europe. *Procedia Economics and Finance*, 34(15), 649–655. [https://doi.org/10.1016/s2212-5671\(15\)01681-0](https://doi.org/10.1016/s2212-5671(15)01681-0)
- Tingsanchali, T. (2012). Urban flood disaster management. *Procedia Engineering*, 32, 25–37. <https://doi.org/10.1016/j.proeng.2012.01.1233>
- UNOOSA/UN-SPIDER. (2020). *Data application of the month: Land degradation*. <https://www.un-spider.org/links-and-resources/data-sources/daotm-river-floods>
- Anilkumar, V. (2021). Iot Based Early Flood Detection and Destruction Avoidance System. *International Journal of Modern Agriculture*, 10(2), 3854–3861.
- Varma, S., Preethi, E., Kumar, R., & Tenali, K. (2019). Internet of Things Based Smart Flood Monitoring & detecting system. *International Journal of Recent Technology and Engineering*, 7(6), 1335–1337.
- Wainwright, M., Finney, L., Kilavi, M., Black, E., & Marsham, H. (2020). Extreme rainfall in East Africa, October 2019–January 2020 and context under future climate change. *Weather*, 3(1), 1–6. <https://doi.org/10.1002/wea.3824>
- Wan, H., Jidin, Z., Aziz, C., & Rahim, N. (2019). Flood disaster indicator of water level monitoring system. *International Journal of Electrical and Computer Engineering*, 9(3), 1694–1699. <https://doi.org/10.11591/ijece.v9i3.pp1694-1699>
- Zurich company. (2019). *Three common types of flood explained | Zurich Insurance*. <https://www.zurich.com/en/knowledge/topics/flood-and-water-damage/three-common-types-of-flood>

## APPENDICES

### Appendix 1: Program source code

Program code for the developed prototype is showing the detected distance, temperature and humidity data outputs, the corresponding message indicating the water level status. The AT commands configuration were also shown.

```
#include<SoftwareSerial.h>
#include<String.h>
#include <DHT.h>
SoftwareSerial mySerial (2,3);
#include <LiquidCrystal.h>

#define trigPin 10
#define DHT11_PIN A0
#define echoPin 13

LiquidCrystal lcd (12, 11, 7, 6, 5, 4);
int Buzzer = 9; // Connect buzzer pin to 9
int ledPin= 8; //Connect LED pin to 8
DHT dht (DHT11_PIN, DHT22);
void setup () {
  mySerial.begin(9600);
  Serial.begin(9600);
  dht.begin();
  pinMode (ledPin, OUTPUT);
  pinMode(trigPin, OUTPUT);
  pinMode(Buzzer, OUTPUT);
  pinMode(echoPin, INPUT);

  if (mySerial.available())
    Serial.write(mySerial.read());

  mySerial.println("AT");
  mySerial.println("AT+CPIN?");
  mySerial.println("AT+CIPSTATUS");
  mySerial.println("AT+CIPMUX=0");
  mySerial.println("AT+CREG?");
  mySerial.println("AT+CGATT?");
  mySerial.println("AT+CIPSHUT");

  ShowSerialData ();

  mySerial.println("AT+CSTT=\"internet\"") ;//start task and setting the APN
  ShowSerialData ();
```

```

    mySerial.println("AT+CIICR"); //bring up wireless connection
    ShowSerialData ();
mySerial.println("AT+CIFSR"); //get local IP address
    delay (500);
    ShowSerialData ();
}

```

```

void loop () {

```

```

    float h = dht.readHumidity ();
    float t = dht.readTemperature ();
    delay (100);

```

```

    Serial.print("Temperature = ");
    Serial.print(t);
    Serial.println(" °C");
    Serial.print("Humidity = ");
    Serial.print(h);
    Serial.println(" %");

```

```

float duration;
float speed;
int distance;

```

```

digitalWrite (trigPin, LOW);
delayMicroseconds (2);
digitalWrite (trigPin, HIGH);
delayMicroseconds (10);
digitalWrite (trigPin, LOW);

```

```

duration = pulseIn (echoPin, HIGH);
speed = 331.4 + (0.606 * t) + (0.0124 * h);
distance = (duration / 2) * (speed / 10000);

```

```

if (distance >= 10) {
    Serial.print("Distance = ");
    Serial.print(distance);
    Serial.println(" cm");
    Serial.println("safe Mode");
    digitalWrite(Buzzer,LOW);
    digitalWrite (ledPin,LOW);
    lcd.print ("Safe mode Mode");
}

```

```

else

```

```

if (distance < 5) {
    SendMessage ();
    Serial.print("Distance = ");
    Serial.print(distance);
}

```

```

Serial.println("cm");
Serial.println("Danger Mode");
DigitalWrite (Buzzer,HIGH);
digitalWrite (ledPin,HIGH);
lcd.print ("Danger Mode");

}
else {
  if ((distance < 10) && (distance = 5)) {
    Serial.print("Distance = ");
    Serial.print(distance);
    Serial.println(" cm");
    Serial.println("Moderate Mode");
    digitalWrite(Buzzer,LOW);
    digitalWrite(ledPin,LOW);
    lcd.print ("Moderate Mode");
    delay (500);
  }
}
delay (500);
lcd.clear ();

mySerial.println("AT+CIPSPRT=0");
ShowSerialData ();
mySerial.println("AT+CIPSTART=\"TCP\", \"api.thingspeak.com\", \"80\"); //start up the
connection
Delay (300);

ShowSerialData ();
mySerial.println("AT+CIPSEND") ;//begin send data to remote server
delay (300);
Serial.println(str);
mySerial.println(str);//begin send data to remote server
delay (300);
ShowSerialData ();
ShowSerialData ();
String str="GET
https://api.thingspeak.com/update?api_key=DNSW9YT5H0UGKG7Q&field1=
="+String(t)+"&field2="+String(h)+"&field3="+String(distance);

mySerial.println((char)26) ;//sending
mySerial.println("AT+CIPSHUT") ;//close the connection
//delay (100);
delay (300); //waiting for reply, important! the time is based on the condition of internet
mySerial.println();
ShowSerialData ();

ShowSerialData ();

```

```

}
void ShowSerialData ()
{
  While (mySerial.available() != 0)
  Serial.write(mySerial.read());
  Delay (3000);
}
void SendMessage ()
{
  Serial.println("I am in send");
  mySerial.println("AT+CMGF=1"); //Sets the GSM Module in Text Mode
  delay (5);
  mySerial.println("AT+CMGS="+255692047521+"\r"); // Number to which you are
sending the message
  delay (5);
  mySerial.println("WARNING!!Danger Conditions") ;// The SMS text you want to send
  delay (5);
  mySerial.println((char)26); // ASCII code of CTRL+Z
  delay (5);
}

```

```
11:26:44.596 -> Temperature = 24.90 °C
11:26:44.643 -> Humidity = 83.10 %
11:26:44.643 -> Distance = 10 cm
11:26:44.643 -> safe Mode
11:26:45.110 -> AT+CIPSHUT
11:26:46.463 -> SHUT OK
11:26:46.509 -> AT+CIPSTART="TCP","api.thingspeak.com","80"
11:26:46.556 -> OK
11:26:47.770 ->
11:26:47.817 -> CONNECT OK
11:26:47.817 -> AT+CIPSENDGET https://api.thingspeak.com/update?api_key=DNSW9YT5HOUGKG7Q&field1=24.90&field2=83.10&field3=10
11:26:49.218 -> GET https://api.thingspeak.com/update?api_key=DNSW9YT5HOUGKG7Q&
11:26:51.556 ->
11:26:51.556 -> SEND OK
11:26:52.685 -> Temperature = 24.90 °C
11:26:52.685 -> Humidity = 83.00 %
11:26:52.733 -> Distance = 5 cm
11:26:52.733 -> Moderate Mode
11:26:53.716 -> AT+CIPSHUT
11:26:55.075 -> SHUT OK
11:26:55.075 -> AT+CIPSTART="TCP","api.thingspeak.com","80"
11:26:55.122 -> OK
11:26:56.377 ->
11:26:56.377 -> CONNECT OK
11:26:56.377 -> AT+CIPSENDGET https://api.thingspeak.com/update?api_key=DNSW9YT5HOUGKG7Q&field1=24.90&field2=83.00&field3=5
11:26:57.826 -> GET https://api.thingspeak.com/update?api_key=DNSW9YT5HOUGKG7Q&
11:27:00.166 ->
11:27:00.166 -> SEND OK
11:27:01.240 -> Temperature = 24.90 °C
11:27:01.286 -> Humidity = 82.80 %
11:27:01.286 -> I am in send
11:27:01.333 -> Distance = 2cm
11:27:01.379 -> Danger Mode
11:27:01.893 -> AT+CIPSHUT
11:27:03.201 -> SHUT OK
```

---

**Appendix 2: System installation in the field (Themí river)**



Appendix 3: Certificate of publication

## Certificate of Publication

### International Journal of Advanced Technology and Engineering Exploration (IJATEE)

This is to certify that Prof./Dr./Ms./Mr. *Ange Josiane Uwayisenga*  
of *Nelson Mandela African Institution of Science and Technology*

has published a research paper entitled

*IoT-based system for automated floodwater detection and early warning in  
the East African region; a case study of arusha and dar es salaam, Tanza-  
nia*

(Volume - 8, Issue - 79, June- 2021)

**International Journal of Advanced Technology and Engineering Explo-  
ration (IJATEE)** is published under Association of Computer Communica-  
tion and Education for National Triumph Society  
(ACCENTS), India.



ISSN:(P):2394-5443  
ISSN:(O):2394-7454



ACCENT SOCIETY  
<http://www.accentjournals.org>  
<http://www.theaccents.org>

*[Signature]*  
**Journal Publication Head**





## RESEARCH OUTPUT

### Publication Paper

Uwayisenga, A., Mduma, N., & Ally, M. (2021). IoT-based system for automated floodwater detection and early warning in the East African region: A case study of Arusha and dar Es Salaam, Tanzania. *International Journal of Advanced Technology and Engineering Exploration*, 8(79), 706–715. <http://dx.doi.org/10.19101/IJATEE.2021.874099>